



# 60 Ton Ironworker Manual

Serial # \_\_\_\_\_

**800-446-4402**

[www.clevelandsteeltool.com](http://www.clevelandsteeltool.com)  
474 E. 105th St. • Cleveland, OH 44108



# Table of Contents

|     |  |
|-----|--|
| 1   | Company Profile, Warranty              |
| 2   | Operator and Supervisor Information    |
| 3   | Requirements                           |
| 4-5 | Signal Panel Information               |
| 6   | Installation                           |
| 7   | Machine Front View                     |
| 8   | Machine Back View                      |
| 9   | Machine Side Views                     |
| 10  | Maintenance Precautions and Schedule   |
| 11  | Operations Diagram                     |
| 12  | Control Panel                          |
| 13  | Electric Stroke Control                |
| 14  | Flat Bar Shear Station                 |
| 15  | Flat Bar Shear Station Maintenance     |
| 16  | Angle Shear Station                    |
| 17  | Angle Shear Station Maintenance        |
| 18  | Coper Notcher Station                  |
| 19  | Coper Notcher Maintenance              |
| 20  | Optional Tooling - Auto cut            |
| 21  | Optional Accessory Light               |
| 22  | Punch Station                          |
| 23  | Punch Operation                        |
| 24  | Optional - Oversize Punch              |
| 25  | Optional - Oversize 241 Punch          |
| 26  | Punch Station Maintenance              |
| 27  | Punch and Die Styles                   |
| 28  | Optional - Angle Notcher               |
| 29  | Angle Notcher Maintenance              |
| 30  | Optional - Press Brake                 |
| 31  | Press Brake Maintenance                |
| 32  | Optional Pipe Notcher                  |
| 33  | Pipe Notcher Maintenance               |
| 34  | Optional - Rod Shear/Multi-Shear       |
| 35  | Rod Shear/Multi-Shear Maintenance      |
| 36  | Optional - Hydraulic Accessory Package |
| 37  | Exploded View                          |
| 38  | Parts List                             |
| 39  | Troubleshooting                        |

# 60 Ton Ironworker

| Technical Specifications  |   |
|---|---|
| Rated capacity<br><small>**Rated at 65,000 psi tensile strength</small> | 60 Ton  |
| Number of work stations   | 4   |
| Throat depth  | 8-7/8"  |
| Maximum capacity  | 1" dia. thru 3/4" plate   |
| Largest standard punch  | 1-1/16" punch   |
| Open height   | 8-1/8"  |
| Closed height   | 6-7/8"  |
| Stroke  | 1-1/4"  |
| Table size  | 6" x 10"  |
| Hydraulic system  | 7 gallon reservoir<br>2,500 PSI, 2-1/2" cylinder  |
| Standard motor  | 5 HP, 3 phase 208V or 230V<br>14 amp  |
| Optional motors   | 5 HP, 3 Phase, 460V - 7 amp<br>5 HP, 3 Phase, 575V - 6 amp<br>5 HP, 1 Phase, 208V or 230V<br>23 amp |
| Dimensions  | 46-1/8" W x 36-1/8" D x 56-1/8" H   |
| Shipping Weight   | 2,550 lbs.  |

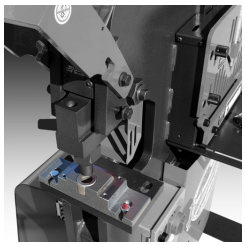
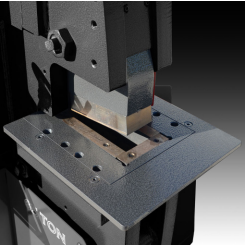
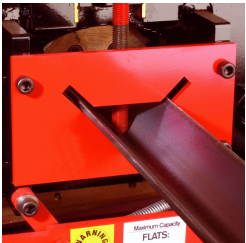
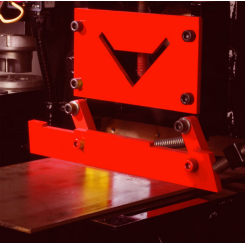

## STANDARD FEATURES

|   |  |  |   |
|---|--|--|---|
|  | Punch Station with pedestal die table<br>219 Punch and 413 Die |  | Cooper Notcher<br>2-1/2" x 4" x 3/8"<br>mild steel                    |
|  | Angle Shear<br>3" x 3" x 1/2"<br>4" x 4" x 3/8"<br>mild Steel  |  | Flat Bar Shear<br>3/8" x 14"<br>1/2" x 12"<br>3/4" x 4"<br>mild Steel |

- Fully guarded
- Gauge table
- Adjustable steel strippers
- Fully charged hydraulic system
- Electric stroke control
- Shear blades reversible for extra long life
- Direct drive pump

## ***Company Profile***

The Cleveland Steel Tool Company offers a full line of high quality, low maintenance hydraulic ironworking machines, associated tooling and accessories that are used in the steel fabrication industry. With proper operation, care, and maintenance, your Cleveland Steel Tool Ironworker will provide years of safe, trouble-free ironworking service. Please take time to study this manual carefully to fully understand Ironworker safety procedures, set-up, operation, maintenance, troubleshooting and warranty coverage prior to putting the machine into production. Any questions not answered within this manual can be directed to The Cleveland Steel Tool Company or visit [www.clevelandsteeltool.com](http://www.clevelandsteeltool.com) for more information.



474 E. 105th St.  
Cleveland, OH 44108  
800-446-4402 ph  
216-681-7009 fx  
[sales@clevelandsteeltool.com](mailto:sales@clevelandsteeltool.com)

## ***Machine Identification***

Your Cleveland Steel Tool Ironworker has been serialized for quality control, product traceability and warranty enforcement. Please refer to the aluminum identification tag with the engraved serial number and electrical and power specifications when ordering parts or filing a warranty claim. Record the serial number on the front of this manual for easy reference.

## ***Warranty***

The Cleveland Steel Tool Company will, within one (1) year of date of purchase, replace F.O.B. the factory, any goods, excluding punches, dies, and/or blades, which are defective in materials and workmanship provided that the buyer returns the defective goods, freight prepaid, to the seller, which shall be the buyer's sole and exclusive remedy for the defective goods. Hydraulic and electrical components are subject to their respective manufacturer's warranties. The Cleveland Steel Tool Company will, within thirty (30) days of date of purchase, replace F.O.B. the factory any punches, dies, and/or blades that prove to be defective in material and workmanship. Proof of purchase date required.

This warranty does not apply to machines and/or components which have been altered, changed or modified in any way, or subjected to abusive and abnormal use, inadequate maintenance and lubrication, or subjected to use beyond seller recommended capacities and specifications. In no event shall seller be liable for labor costs expended on such goods or consequential damages. Seller shall not be liable to the purchaser or any other person for loss, downtime, or damage directly or indirectly arising from the use of the goods or from any other cause. No officer, employee, or agent of seller is authorized to make any oral representations or warranty of fitness or to waive any of the foregoing terms of sale and none shall be binding on seller.

## Operator and Supervisor Information

This manual includes information on:

- Installation
- Safety
- Operation
- Maintenance

*READ ALL INSTRUCTIONS BEFORE OPERATING MACHINERY.* Operating machinery before reading and understanding the contents of this manual greatly increases the risk of injury.

This manual describes 'best practices' in handling, installing, operating and maintaining your machine. The contents are subject to change without notice due to improvements in the machinery or changes in National or International standards.

All rights reserved. Reproduction of this manual in any form, in whole or in part, is not permitted without the written consent of Cleveland Steel Tool.

Keep this manual close to the machine to allow for easy reference when necessary.

Provide operators with sufficient training and education in the basic functions of the machine prior to machine operation.

Do not allow for operation of the machine by unqualified personnel. Cleveland Steel Tool is not liable for accidents arising from unskilled, untrained operation.

Do not modify or change the machine without written authorization from Cleveland Steel Tool. Unauthorized modification to a machine may result in serious operator injury, machine damage and will void your machine warranty.

Never leave a powered machine unattended. Turn machinery OFF before walking away.

This machine is manufactured for use by able bodied and able minded operators only. Never operate machinery when tired or under the influence of drugs or alcohol.

Do not resell, relocate or export to a destination other than to the original point of sale. Cleveland Steel Tool has designed this machine to meet the standards of the original receiving country and is not liable for meeting any governing body or performance standards beyond those of the original receiving country.

## Signal Word Definition



Indicates a hazardous situation that, if not avoided, will result in death or serious injury.



Indicates a hazardous situation that, if not avoided, could result in death or serious injury.



Indicates a hazardous situation that, if not avoided, could result in mild or moderate injury.



Indicates information considered important, but not hazard related.

## Signal Word Panel on Machine



Critical machine safety information is identified on signal word labels. Labels are attached adjacent to the potentially hazardous locations of the machine. Reference safety instructions for additional information regarding the potentially hazardous condition identified on the label.

Review ALL labels on the machinery, reference the operational precautions and safe operations sections within this manual before any operation activity is initiated.

Failure to read and understand the signal word labels affixed to the machinery may result in operator death or injury.

## Installation Requirements

This manual provides installation information for the following Cleveland Steel Tool Ironworker: **60 Ton**

## Environmental Requirements

### NOTICE

The work station environment for your Cleveland Steel Tool Ironworker must meet the following minimum requirements:

- **Floor area:** Assure that the machinery work area provides for a stable, adequately sized and load rated floor area for material movement to and from the machinery work stations.
- **Shelter:** Cleveland Steel Tool Ironworkers are designed for indoor use only. Protect your Ironworking machinery from water, salts and corrosive elements.
- **Lighting:** 60 Watts (500LUX or 50 footcandles) minimum.
- **Operating Temperature:** This equipment will operate correctly in its intended ambient, at a minimum between 41° F -104° F.
- **Relative Humidity:** This equipment will operate correctly within an environment at 50% RH, 41° F - 104° F. Higher RH may be allowed at lower temperatures. Measures shall be taken by the Purchaser to avoid the harmful effects of occasional condensation.
- **Altitude:** This equipment will operate correctly up to 3,281 feet above mean sea level.
- **Transportation and Storage:** This equipment will withstand, or has been protected against, transportation and storage temperatures of -13° F to +131° F and for short periods up to 158° F. It has been packaged to prevent damage from the effects of normal humidity, vibration and shock.

## Environmental Requirements

### DANGER

Locate your Cleveland Steel Tool Ironworker directly adjacent to your power supply. Confirm that power supply is not connected in series with other machinery. Provide dedicated electrical socket and circuit breaker for each Ironworker installed. Cleveland Steel Tool Ironworkers are protected from voltage variations provided the variation does not exceed +/- 10% machine rating.

## Electrical Performance Specification

| Machine     | Motor #    | Type   | Brand  | 60Hz/V            | FLA  | 50Hz/V        | FLA   |
|-------------|------------|--------|--------|-------------------|------|---------------|-------|
| 60 Ton,     | 132089     | 5Hp 1~ | Leeson | 60 Hz 230         | 19   | 50 Hz 208-220 | 23-22 |
| Porta-Power | 132077     | 5Hp 3~ | Leeson | 60 Hz 208-230/460 | 14/7 | 50 Hz 190/380 | 16/8  |
|             | CEM3615T-5 | 5Hp 3~ | Baldor | 60 Hz 575         | 5    |               |       |

## Danger Panel

### **DANGER**

#### Electrical Hazard

High voltages present inside the enclosure of this product. ONLY qualified, authorized, maintenance, service or Certified Electricians should gain access to electrical panel. Do not operate this equipment from any power source that does not match the voltage rating stamped on the equipment. Refer to the Manufacturer's Identification Label for operational requirements.



#### Lockout Power

Danger circuits are live. Lockout/Tagout the upstream power source. Lockout/Tagout machinery according to Employer procedures.



#### Voltage (Varies by consumer requirement)

Indication of operating power requirements. This product should be operated only from the type of source indicated on the manufacturer's identification label. Installation should be in compliance with applicable sections of the National Electric Code. Consult your local building code before installing.

208 V

230 V

460 V

575 V

#### Phase (Varies by consumer requirement)

Indication of electrical phase requirements. This product should be operated only from the type of source indicated on the manufacturer's identification label. Installation should be in compliance with applicable sections of the National Electric Code. Consult your local building code before installing.

1~

3~

#### Horsepower

Indication of horsepower requirements. This product should be operated only from the type of source indicated on the manufacturer's identification label. Installation should be in compliance with applicable sections of the National Electric Code. Consult your local building code before installing.

5 hp

#### Hertz

Indication of electrical cycles per second. This product should be operated only from the type of source indicated on the manufacturer's identification label. Installation should be in compliance with applicable sections of the National Electric Code. Consult your local building code before installing.

60 Hz

## Warning Panel

### **WARNING**

#### Shear/Crush Hazard

Moving parts can cut and crush. Keep hands clear while operating. Lockout power before servicing. Immediately replace guards after adjustment, repair or service.



#### Wear Personal Protective Equipment

To avoid physical hazard, always wear personal protective equipment. Wear protective eye-wear, clothing, gloves, footwear, head-gear and hearing protection while operating or servicing this machinery.



#### Fluid Injection Hazard

Hydraulic hoses and cylinders are under pressure. Pressurized fluid can pierce skin and cause severe injury. To avoid physical hazard, always wear personal protective equipment. Keep hands clear while operating. Lockout power before servicing. Immediately replace guards after adjustment, repair or service.



#### Do Not Operate With Guard Removed

Physical barriers and guards have been designed and installed to protect the operator from moving parts that can pinch, cut and crush. Keep hands clear while operating. Lockout power before servicing. Immediately replace guards after adjustment, repair or service to moving parts.



#### Heat Hazard

To avoid physical burn hazard, always wear personal protective equipment. Wear protective clothing and gloves while working adjacent to or on the affected surface.



Visit our website to view our Ironworkers in action.  
<https://www.clevelandsteeltool.com/catalog-and-literature/videos>



## Notice Panel

### NOTICE

#### Ironworker Operation

This manual outlines the basic functions associated with typical Ironworker operations and is neither intended to create a comprehensive list, nor describe every operation possible with an Ironworker tool. Ironworker machines are designed to punch, shear and notch mild steel (A36) plate, barstock and angle. A wide range of accessories are available to fabricate rod, square stock, sheet metal and pipe. Cleveland Steel Tool Ironworkers operate by applying hydraulic force to a moving center. The center moves within a frame in a simple, vertical path and exerts force through Shear Blades, Punches and Dies, Notchers, Press Brake dies or Rod/Multi-Shear tooling upon A36 mild steel. Cleveland Steel Tool Ironworkers are designed for single operator use only. DO NOT USE THIS EQUIPMENT FOR ANY PURPOSE NOT DESCRIBED IN THE MANUAL. Ironworker machines are dangerous and require extreme care and caution in the safe installation, operation and maintenance of the machinery. Cleveland Steel Tool strongly suggests reading and understanding the manual associated with the machinery as well as obtaining certified, technical, industrial machinery operations and maintenance training to reduce the risk of injury. Regardless of the contents of the machinery manual, Cleveland Steel Tool will not be held liable for accidents caused by lack of training.



#### Safety, Installation, Operations and Maintenance

This manual contains critical instructions regarding proper procedures for your machinery. Understand the contents thoroughly. Failure to follow proper procedures may result in serious operator injury, machine damage and will void your machine warranty. Keep the manual close to the machine for easy reference.



#### Wear Personal Protective Equipment

To avoid physical hazard, always wear personal protective equipment. Wear protective eyewear, clothing, gloves, footwear, head-gear and hearing protection while operating or servicing this machinery.



#### Forklift Location

This machine is equipped with rated forklift movement points. Do not attempt to lift the machinery by any other means. Inappropriate movement of the machinery may result in serious operator injury, machine damage and will void machine warranty. Consult the installation manual for equipment weight ratings. Provide rated forklift and certified forklift operator to move machinery to appropriate location.



## Additional Graphic Information



PE  
'Protective earth', electrical grounding location.



Safety Ground  
Safety earth ground location.

#### Do Not Use Non-Approved Lubricants

This machine requires lubrication of moving mechanical parts (grease) and the maintenance of hydraulic fluids. Refer to maintenance sections for specific lubrication requirements and application or maintenance schedules.



#### Electric Motor Rotation

MOTOR  
ROTATION

ISO VISCOSITY 46  
HYDRAULIC OIL

Identification of proper electrical motor rotation.



#### Conformité Européenne

Conformity with all legal requirements pertaining to the equipment with the European Economic Area.



#### Hydraulics

Hydraulic fluids must be recycled as required by local environmental law. Do not dispose of by adding to the municipal waste stream.



#### Electronics

Electronic equipment must be recycled as required by local environmental law. Do not dispose of by adding to the municipal waste stream.



#### Metal

Metal components must be recycled as required by local environmental law. Do not dispose of by adding to the municipal waste stream.

# Installing the Ironworker

## Receiving the Ironworker

### **WARNING**

Cleveland Steel Tool Ironworking machinery is fully assembled and is shipped either by palletized custom wooden crate or by shrink-wrapped wooden pallet for ease of transport and receiving.

Inspect the packaging for damage and follow shipping/receiving instructions as listed on the packaging prior to receiving the Ironworker into your facility.

When receiving your Ironworker, be prepared to safely move your machinery with a fork-lift rated for the following equipment weights:

#### Minimum Machinery Weights

|        |                       |
|--------|-----------------------|
| 60 Ton | 1,156.7 kg / 2,550 lb |
|--------|-----------------------|

Utilize best practices for fork-lift operation. Handle material as close to the drive surface as possible with the widest spread and deepest penetration of forks effective to service the pallet. Forks should be adjusted and locked into the safety detent closest to the maximum available fork spread.

## Unpacking/Moving the Ironworker

Your Cleveland Steel Tool Ironworker includes surface and remotely mounted electrical cabling and hydraulic lines. Exercise caution when removing the factory supplied packaging. Do not cut electrical wires or hydraulic hoses.

1. Unbolt/unpack Ironworker from its pallet using a 3/4" (19.05mm) socket. Wear appropriate personal protective equipment.
2. Lift Cleveland Steel Tool machinery using the designated fork lift locations and appropriately rated lifting equipment.
3. Move the Ironworker to the prepared workstation.

## Anchoring the Ironworker

Anchor the base of the Ironworker to the workstation floor using four 1/2" (12.7 mm) wedge anchor bolts. Anchorage points are the front and rear of the fork-lift tubes. Secure the machinery with lock-nuts. In the event the machinery needs to be relocated, reverse procedure.

## Electrical Connection

Confirm with a certified electrician that the electrical supply to the terminal location powering your Ironworker meets the operating specifications of the machine prior to electrical connection.

Confirm your electrical supply with the electrical specifications of the machine located on the Ironworker starter box. It is critical that a qualified electrician install your machinery as your Warranty protection does not cover incorrect wiring of electrical components at your site.

### **DANGER**

Prior to connecting your machine to the dedicated, protected power supply, match work station wiring to the power supply cable (Owner supplied) and the starter-box/motor specifications on the machinery. Install connections appropriately. Check for stability of connections.

If wiring through a plug/socket connection at the work station, match work station wiring to the socket (Owner supplied), plug (Owner supplied) and the power supply cable (Owner supplied) to the starter-box / motor specifications on the machinery. Install connections appropriately. Check for stability of connections.

Wire according to the electrical diagrams located within the control box.

## Starter Box Wiring

### **WARNING**

Provide the electrical schematic wiring diagram (located within the Ironworker control box) to your Electrician prior to initiating the electrical hookup of the machine.

## Power up the Ironworker

### **WARNING**

With all stations clear of tools, tooling or debris, power up the Ironworker by depressing the green button on the starter box. With the power on, your machine will return to a neutral position.

Cycle the machinery by depressing the foot pedal. If pressure is released at the foot pedal prior to completing a full stroke, the operating center of the machinery will return to a neutral position.

If the machinery fails to cycle the motor may be rotating incorrectly. To ensure the machinery cycles properly, simply reverse two of the phase wires on the machine starter box.

If the machine fails to cycle, power down the Ironworker by depressing the red button on the starter box, Lockout / Tagout the upstream power and consult the trouble shooting section of this manual.

# Signal Word Panel • Machine Front

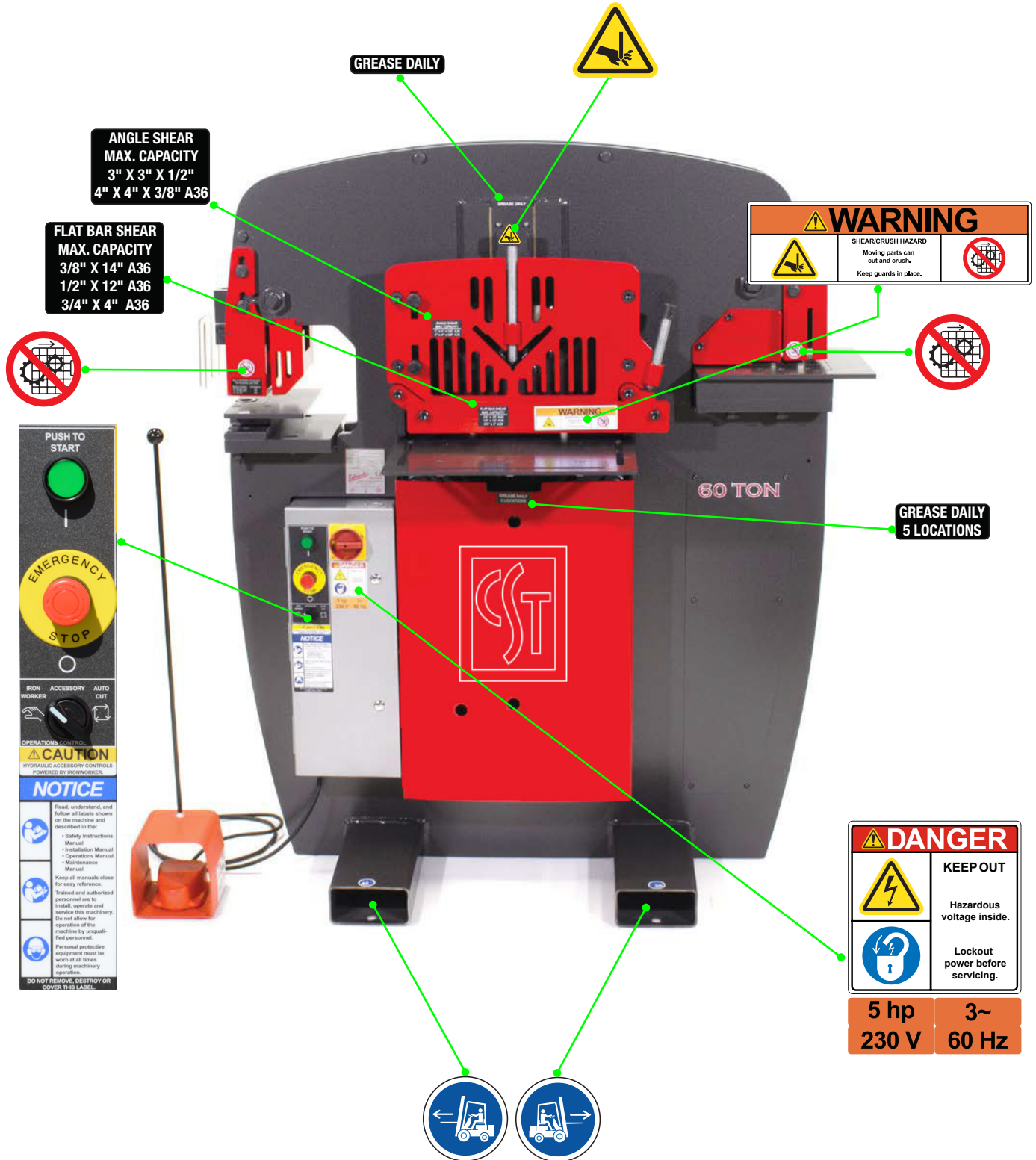

**ANGLE SHEAR  
MAX. CAPACITY**  
3" X 3" X 1/2"  
4" X 4" X 3/8" A36

**FLAT BAR SHEAR  
MAX. CAPACITY**  
3/8" X 14" A36  
1/2" X 12" A36  
3/4" X 4" A36

**GREASE DAILY**

**WARNING**  
SHEAR/CRUSH HAZARD  
Moving parts can cut and crush.  
Keep guards in place.

**60 TON**

**GREASE DAILY  
5 LOCATIONS**

**PUSH TO START**

**EMERGENCY STOP**

IRON WORKER    ACCESSORY    AUTO CUT

**CAUTION**  
HYDRAULIC ACCESSORY CONTROLS  
POWERED BY BROWWORDERS.

**NOTICE**

Read, understand, and follow all labels shown on the machine and described in the:

- Safety Instructions Manual
- Installation Manual
- Operations Manual
- Maintenance Manual

Keep all manuals close for easy reference. Trained and authorized personnel are to install, operate and service this machinery. Do not allow for operation of the machine by unqualified personnel. Personal protective equipment must be worn at all times during machinery operation.

DO NOT REMOVE, DESTROY OR COVER THIS LABEL.

**DANGER**

**KEEP OUT**  
Hazardous voltage inside.

Lockout power before servicing.

**5 hp    3~  
230 V    60 Hz**



# Signal Word Panel • Machine Back

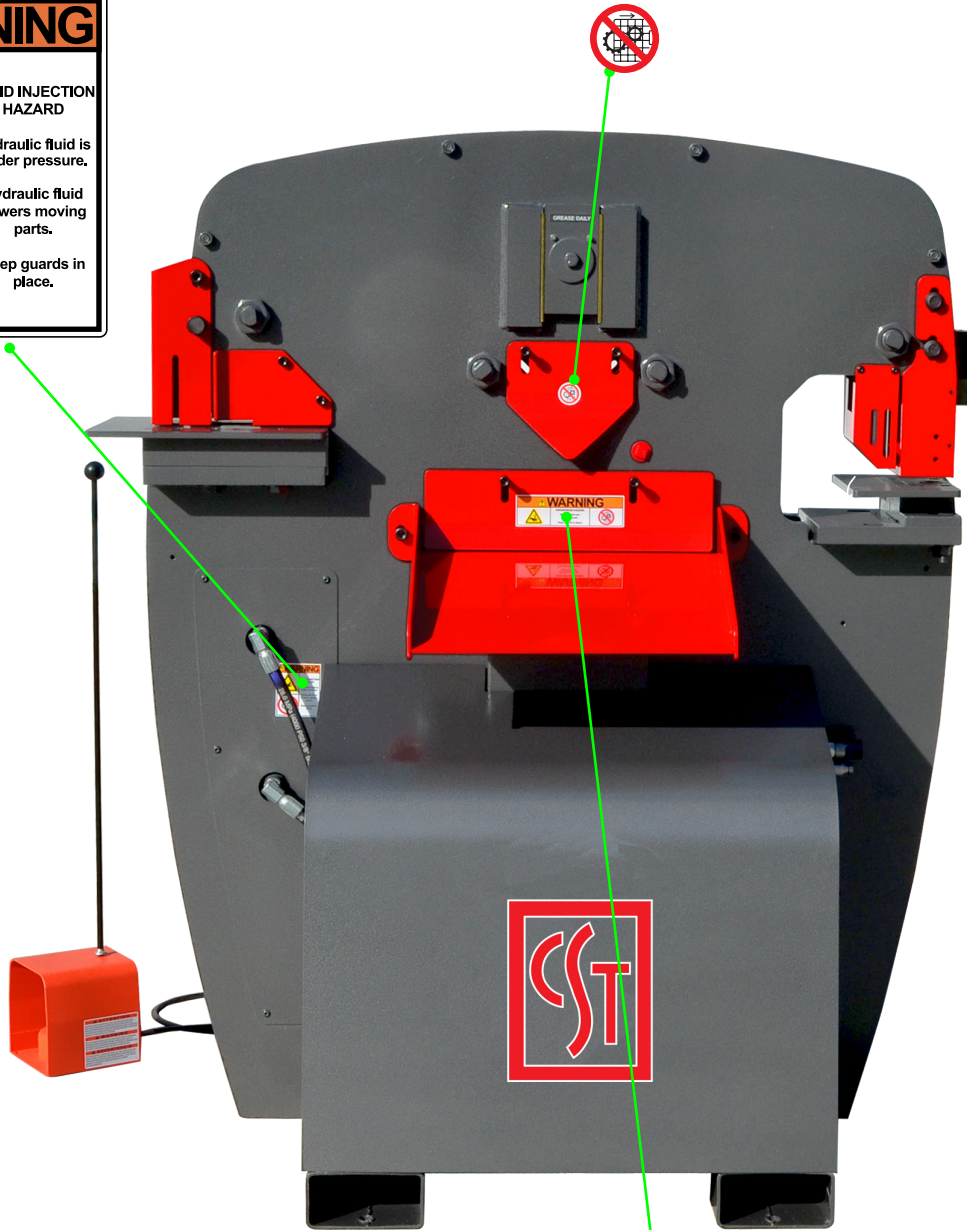
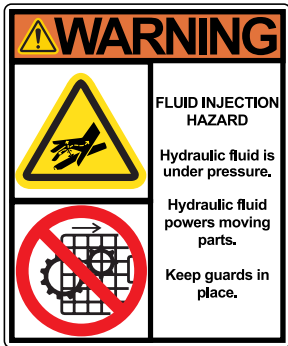

# Signal Word Panel

Machine Left

Machine Right

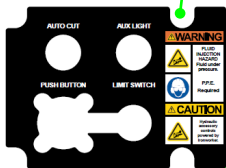
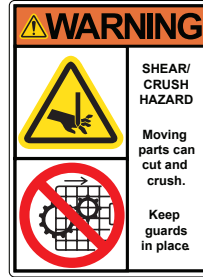

Optional Hydraulic Accessory Pack

MOTOR ROTATION  ISO VISCOSITY 46 HYDRAULIC OIL

**WARNING**  
 THIS FOOT SWITCH SHOULD ONLY BE USED WHERE POINT OF OPERATION GUARDING DEVICES HAVE BEEN PROPERLY INSTALLED SO THAT IT IS IMPOSSIBLE FOR THE OPERATOR'S HANDS OR FINGERS TO REMAIN WITHIN THE POINT OF OPERATION DURING THE ACTUAL MACHINE CYCLE.

## Maintenance Precautions

Your Cleveland Steel Tool Ironworker will benefit from reasonable care and periodic maintenance. Reasonable care includes daily visual observation, general maintenance daily, weekly, monthly and at hourly milestone intervals by operator/maintenance personnel. Perform inspections and maintenance of the electrical, hydraulic, and mechanical systems of the Ironworker and any optional Cleveland Steel Tool hydraulic accessory connected to the Ironworker as follows:



### Daily/Shift Change Visual Observation

#### Electrical System

Visually inspect incoming power and exposed surface conduit or cabling on the Ironworker for signs of damage. Cut, abraded or crushed electrical cords may present an electrical hazard to the Operator and damage the machinery. Replace fuses as necessary with same type and rating. Fuses located behind control box. See Figure 1 below.

#### Hydraulic System

Visually inspect exposed or surface mounted hydraulic hoses and fittings for signs of damage. Cut, abraded or crushed hydraulic hoses or leaking fittings may present a hydraulic fluid hazard to the Operator and damage the machinery.

Plug hose ends when working with hydraulic fluids and clean up spills near the machinery in a timely manner to reduce the likelihood of spills, trips and falls.

#### Mechanical System

Visually inspect guards and material hold-downs protecting moving parts. Guards and material hold-downs must remain on the machine for safe operation. Clear any material obstructions at the work stations prior to visually inspecting moving parts of the machine. Cycle the machine. Machine should operate smoothly in hydraulic extend and retract mode.

Observe mechanical operating clearances. Punches, dies, angle shear, notchers and bar shear blades should be evenly gapped and free of nicks, chips or burrs on their surface.

Ironworker operation creates small concussive shocks and vibration that may loosen hardware and fasteners over time. Inspect fasteners and fittings and tighten where loose.

#### Slipping, Tripping and Falling

During routine maintenance hydraulic fluid could spill outside of the machine footprint. Plug hose ends when working with hydraulic fluids and clean up spills near the machinery in a timely manner.

**Figure 1 - Fuses**

| Part # | Volts | Phase | Hertz | FLA      | Fuse       | Part #   | Voltage | Amperage | SC/IR  | Class | Qty. |
|--------|-------|-------|-------|----------|------------|----------|---------|----------|--------|-------|------|
| 213197 | 230 V | 1~    | 60 Hz | 19.2 FLA | Littelfuse | JTD040   | 600 VAC | 40 A     | 200 kA | J     | 2    |
| 213198 | 230 V | 3~    | 60 Hz | 13.6 FLA | Littelfuse | JTD025   | 600 VAC | 25 A     | 200 kA | J     | 3    |
| 213201 | 460 V | 3~    | 60 Hz | 6.8 FLA  | Littelfuse | JTD012   | 600 VAC | 12 A     | 200 kA | J     | 3    |
| 213202 | 575 V | 3~    | 60 Hz | 5.7 FLA  | Littelfuse | JTD010ID | 600 VAC | 10 A     | 200 kA | J     | 3    |

## Maintenance Schedule

Failure of any element of the daily/shift change visual observation will require maintenance of the affected Ironworker or accessory component. Please follow the following maintenance procedures.



### LOCKOUT POWER TO MACHINE FOR ALL MAINTENANCE

#### General Maintenance - Daily

Clean your Ironworker daily with a compressed air nozzle and soft cloth lightly moistened with a mild, water based detergent solution. Remove filings, dirt, dust and grime and excess lubricant from working surfaces. All clean surfaces must be fully dry before powering up machine. Grease all machine guides and pins supplied with a GREASE DAILY designation with NLGI Grade 2 (NLGI Service GC-LB) or equivalent premium, heavy duty lubricant.

#### General Maintenance - Weekly

Check blade tolerance per maintenance section of each attachment.

#### General Maintenance - Monthly

Check gib-pins for lubrication and snugness to the operating center. Tighten gib-pins and locking nuts to maintain blade clearance as indicated above. Gib-pins are wearing parts. Order replacement gib-pins through Cleveland Steel Tool. Check the ISO Viscosity 46 hydraulic fluid level monthly. Maintain the correct volume of hydraulic fluid in the reservoir as indicated. Contaminated fluid will compromise your cutting operation.

#### General Maintenance - First 30 Hours

Replace the oil filter on your Ironworker after your first 30 hours of use. External oil filters are available through Cleveland Steel Tool. When working on the hydraulic power, use plugs to cap hose ends during maintenance procedures to minimize fluid loss. Clean up spills near the machinery to reduce the likelihood of slips, trips and falls.

#### General Maintenance - Every 1,000 Hours

Replace the oil filter on your Ironworker after your first 1,000 hours of use. External oil filters are available through Cleveland Steel Tool. When working on the hydraulic power, use plugs to cap hose ends during maintenance procedures to minimize fluid loss. Clean up spills near the machinery to reduce the likelihood of slips, trips and falls.

#### General Maintenance - Every 5,000 Hours

Drain used hydraulic fluid, dispose of according to local or jurisdictional guidelines and replace with ISO Viscosity 46 hydraulic fluid to the volume specified on the hydraulic fluid reservoir.

# Operations Diagram

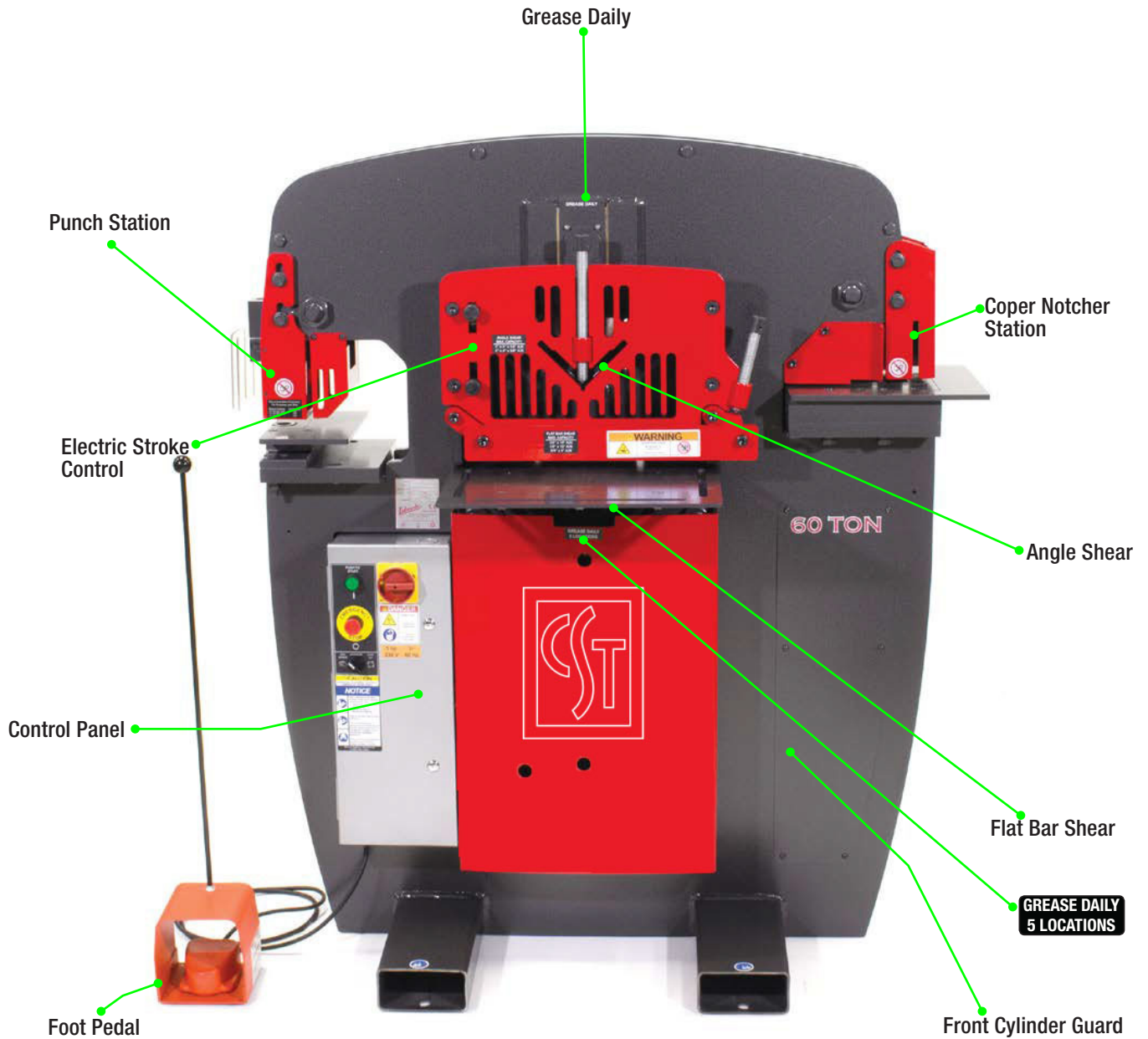

Visit our website to view our Ironworkers in action.  
<https://www.clevelandsteeltool.com/catalog-and-literature/videos>



## Control Panel



Cleveland Steel Tool Ironworkers feature a centrally located, integrated Control Panel. Hazardous voltage is present within the control panel. The panel should only be opened and serviced by authorized personnel. An external power source enters this panel and is distributed to the various working components of the machine.

### Push to Start

This button energizes the machine. When energized this recessed button is internally illuminated and will glow green. If the machine does not start when pressed an emergency palm stop button may have been previously pressed and will need to be reset to allow for the start button to energize the machine.

### Emergency Palm Stop

This button de-energizes the machine and contains a manual, safety reset function. The projecting, red, palm stop style button is set within a safety yellow bezel and is pushed to de-energize the machinery. Once de-energized the machine requires the palm stop to be re-set prior to energizing the machine. Simply rotate the emergency palm stop button clockwise. The button will retract and the machine will be available for powered operation.

### Operations Control

This three-position switch allows the ironworker operation to shuttle between Ironworker, hydraulic accessory (optional) or auto-cut (optional) mode.

### Ironworker

Power the Ironworker by rotating the three position switch counter-clockwise. This function allows for operations of the Ironworker only.

### Lockout/Tagout

This round, safety red switch is set within a square, safety yellow housing. The switch allows for proper procedures to be followed when de-energizing, isolating, and ensuring the energy isolation of the Ironworker. The Lockout/Tagout switch is used, in conjunction with Owner safety and maintenance programs to ensure that equipment and machinery is de-energized and isolated from unexpected start-up by physically locking machinery in a state of zero energy.

To lockout the Ironworker turn the red switch counter-clockwise until the black tagout bar is horizontal. Pull the black, spring-loaded tagout mechanism to install the maintenance/safety lock and tag provided by the Owner of the machinery. The machine is now de-energized and is available for authorized personnel to maintain and service the machinery.

To open the control panel for servicing, gently pull the 'hopper-style' hinged cover. The cover will not open fully until a safety yellow thumb slide located within the safety yellow housing is rotated clockwise. Reverse operation following service to resume Ironworking.



# Electric Stroke Control

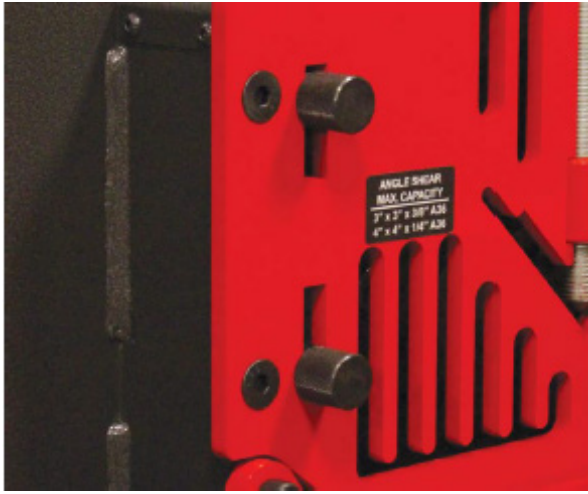

## **WARNING**

Electric stroke control is standard on all Ironworker models with the exception of the 25 Ton Ironworker. Stroke control enables the Ironworker operator to shorten up and down stroke with minor adjustment of two hand screws. Utilize stroke control for precision bending with your brake tooling, when using embossing or bump dies or to simply increase production from your punch, notch or shear stations.

### Setup

Electric Stroke control is factory installed and arrives fully set up for immediate use.

### Safe Operation

Observe the following guidelines when using and adjusting the electric stroke control function:

- Read, understand and follow punching, notching and shearing tolerances as described in this manual.
- Never exceed the capacities of the machine or tooling as described in the Ironworker specifications or listed at the tooling station.
- Keep limit switches free of dirt and grime.
- Never remove stroke retention nuts from factory setting.
- Never reverse stroke limit switches.
- Confirm that red light is illuminated. If not illuminated, machine cycle is not complete and potential heat build-up may occur.

## Electric Stroke Control Operation

**Set upstroke for rapid cycling of your punching, shearing and notching stations.**

1. Power machine on and use the jog function of your electric foot pedal to bring tooling down to rest just above the material being worked.
2. Turn machine off.
3. Adjust upper handle with tapered collar to engage limit switch.
4. Power machine on. Tooling will stay in set position. Top limit switch will be showing a red light.
5. Remove material from tooling station and cycle machine. Tooling should return to pre-set position. Red light will be on.
6. Place material in tooling station and cycle machine.

### Set downstroke for Optional Tooling operation

1. Power machine on and use the jog function of your electric foot pedal to bring ram down to engage tooling. Jog ram to push tooling to the specified depth.
2. Turn machine off.
3. Adjust lower handle with tapered collar to engage limit switch.
4. Power machine on. Ram will return to top of stroke.
5. Cycle machine to insure proper stroke depth.
6. Place material in tooling station and cycle machine.

### Set downstroke for brake operation

1. Power machine on and use the jog function of your electric foot pedal to bring ram down to engage tooling with material.
2. Jog ram to push brake die tooling to the specified depth / brake angle.
3. Turn machine off.
4. Adjust lower handle with tapered collar to engage limit switch.
5. Power machine on. Ram will return to top of stroke. Red light will be on.
6. Place test material in tooling station and cycle machine to insure proper stroke depth and material brake.

## Flat Bar Shear Station



### **WARNING**

Your Ironworker includes a flat bar shear as a standard feature. The flat bar shear will provide a distortion and burr free shear cut to mild steel bar stock as listed in the machine specifications as well as described on the capacity labels positioned at the Flat Bar Shear Station. The Flat Bar Shear allows for straight or angled cutting operations. The material hold down adjusts with a simple hand crank to safely restrain the material being cut.

***The Flat Bar Shear is factory set to proper clearances and is ready to begin shearing operations. Clearances should not be altered.***

Shear blades are wearing parts and will need to be maintained or replaced over time. Refer to page 15 for blade maintenance, removal and replacement.

### Safe Operation

Observe the following guidelines when operating the Flat Bar Shear Station:

- Never exceed the capacities of the machine or tooling as described in the Ironworker specifications or listed at the tooling station.
- Fully engage the material hold-down with the material being cut.
- Do not stack material to cut in the shear station.
- Perform complete shear operations only – partial shear cuts may jam the drop off side of the frame and could result in breakage and operator injury.
- Use shearing aids when working with small items at the shear station.

### Bar Shear Operation

1. Clear bar shear station of any tools or debris prior to powering the machine on.
2. Turn machine on. The shear blades will be in their neutral position. Place bar stock on the feed table and push the material under the material hold-down. Position your desired cut mark adjacent to the moving shear blade.
3. Secure the bar stock in the material hold-down by engaging the handscrew into the material.
4. Clear your hands from the working area and depress the foot pedal to activate the shear station.
5. When the cut is complete, release the foot pedal to automatically return the shear blades to their neutral position. Reverse the hand screw to raise the manual material hold-down and remove your material.

## Maintenance - Flat Bar Shear

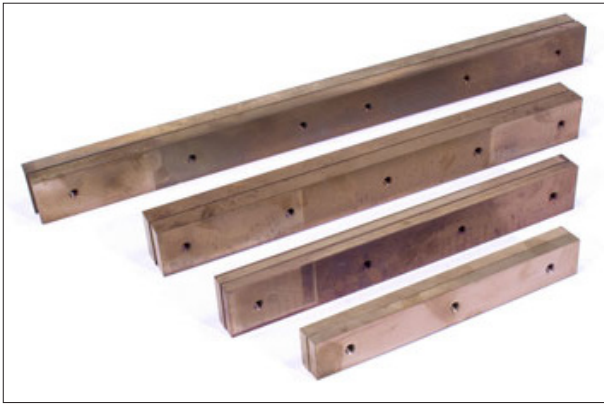

### CAUTION

*Turn off power to machine by depressing the red stop/off button and lockout upstream power at the main electrical panel.*

*Clearances should not be altered. When all 4 cutting edges are worn, replace blades.*

#### Remove and replace stationary blade:

1. Remove the material hold-down assembly from the Ironworker frame by removing the return spring and bolts that secure the assembly to the Ironworker frame.
2. Remove blade bolts located under the feed table. Remove the stationary blade.
3. With blade removed, clean blade pocket of any dirt or debris.
4. Your shear blades have multiple cutting surfaces that can be flipped and rotated prior to full replacement of the part. Rotate the stationary blade to new cutting surface and reinstall in blade pocket.
5. Tighten the stationary blade back into the blade pocket.

#### Remove and replace moving blade:

1. Remove the drop-off guard from the rear of the Ironworker frame.
2. Power on the machine and inch the moving center down to reveal blade bolts for the moving blade.

3. With bolts exposed, turn machine off and disconnect from power source.
4. Remove blade bolts and remove blade from the blade pocket.
5. With blade removed, clean blade pocket of any dirt or debris.
6. Your shear blades have four cutting surfaces that can be used prior to full replacement of the part. Rotate the movable blade to new cutting surface and reinstall in blade pocket.
7. Tighten the movable blade back into the blade pocket.
8. Replace the drop-off guard to the rear of the frame.
9. Return the machine to power and turn on to automatically return the moving center to its neutral position.
10. Replace and secure guarding removed in the maintenance procedure.
11. Replace the material hold-down assembly to the Ironworker frame.

# Angle Shear Station



## **WARNING**

Your Ironworker includes an angle iron shear as a standard feature. The angle shear will provide a distortion and burr free shear cut to mild steel angle stock as listed in the machine specifications as well as described on the capacity labels positioned at the Angle Shearing Station. The Angle Shearing Station on the Cleveland Steel Tool Ironworker allows for straight cutting applications. An oversized material hold down adjusts with a simple thumb crank to safely restrain the material being cut.

***Integrated angle shears are factory set to proper clearances and are ready to begin shearing operations. Clearances should not be altered.***

Shear blades are wearing parts and will need to be maintained or replaced over time. Refer to page 17 for blade maintenance, removal and replacement.

### Safe Operation

Observe the following guidelines when operating the Angle Shear Station:

- Never exceed the capacities of the machine or tooling as described in the Ironworker specifications or listed at the tooling station.
- Fully engage the material hold-down with the material being cut.
- Do not stack material to cut in the shear station.
- Perform complete shear operations only – partial shear cuts may jam the drop off side of the frame and could result in breakage and operator injury.
- Do not shear angle smaller than the hold-down will accommodate.

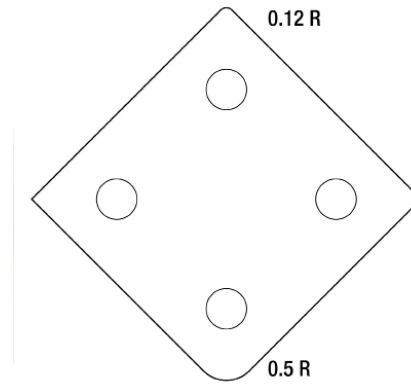

To eliminate distortion with "light" angle iron, use this cutting edge.

### Angle Shear Operation

1. Clear shear station of any tools or debris prior to powering the machine on.
2. Turn machine on. The shear blades will be in their neutral position. Place angle iron into the material hold-down and position your cut mark adjacent to the moving shear blade.
3. Secure the angle iron in the material hold-down by engaging the handscrew into the material.
4. Clear your hands from the working area and depress the foot pedal to activate the shear station.
5. When the cut is complete, release the foot pedal to automatically return the shear blades to their neutral position. If equipped with the hydraulic hold-down feature, the hold-down will retract when pressure on the foot pedal is released at the end of the cut cycle.
6. Reverse the thumb screw to raise the material hold-down and remove your material.

## Maintenance - Angle Shear Station



### CAUTION

*Turn off power to machine by depressing the red stop/off button and lockout upstream power at the main electrical panel.*

*Clearances should not be altered. When all cutting edges are worn, replace blades.*

#### Remove and replace stationary blade:

1. Remove the material hold-down assembly from the Ironworker frame by removing the bolts that secure the guard / hold-down assembly to the Ironworker frame.
2. Remove blade bolts located behind the guard. Remove the stationary blades.
3. With blades removed, clean blade pocket of any dirt or debris.
4. Your shear blades have multiple cutting surfaces that can be used prior to full replacement of the part. Rotate the stationary blades to new cutting surface and re-install in blade pocket.
5. Tighten the stationary blades back into the blade pocket.
6. Replace and secure the material hold-down and guarding to the Ironworker frame.

#### Remove and replace moving blade:

1. Remove the angle shear drop-off guard from the rear of the Ironworker frame.
2. Power on the machine and inch the moving center down to reveal blade bolts for the moving blade.
3. With bolts exposed, turn machine off and disconnect from power source.
4. Remove blade bolts and remove blade from the blade pocket.
5. With blade removed, clean blade pocket of any dirt or debris.
6. Your shear blades have multiple cutting surfaces and two radius options that can be used prior to full replacement of the part. Rotate the movable blade to the appropriate radius and new cutting surface and re-install in blade pocket. See diagram (pg. 16) for correct radius designation.

7. Tighten the movable blade back into the blade pocket.
8. Replace the drop-off guard to the rear of the Ironworker frame.
9. Return the machine to power and turn on to automatically return the moving center to its neutral position.
10. Replace and secure the material guard and hold-down assembly to the Ironworker frame.

# Coper Notcher Station

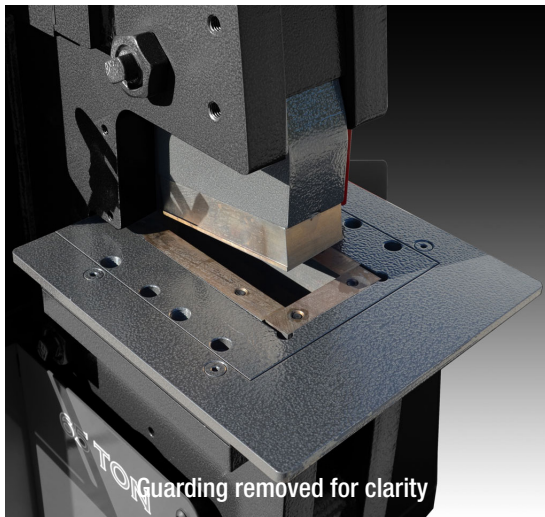

## **WARNING**

Coper Notcher tooling will provide a distortion and burr free, three-sided shear cut to mild steel bar, plate, or angle stock as listed in the machine specifications as well as the capacity labels positioned adjacent to the Notching Station. The Coper Notcher tooling for a Cleveland Steel Tool Ironworker allows for shaped, straight or angled notch cutting applications.

### Safe Operation

Observe the following guidelines when operating the Coper Notcher Station.

- Never exceed the capacities of the machine or tooling as described in the Ironworker specifications or listed at the tooling station.
- Check notcher blade clearance at every tooling change or extended operation. Maintain .010" clearance between top and bottom notcher blades at all times. Failure to maintain clearance will damage blades and support pockets.
- Cut with a minimum two of three sides of the blade surfaces engaging the material being notched. Cutting on one blade surface may overload the blades and result in tooling damage or injury to the operator. See Figures A,B,C.
- Do not stack material to cut in the Coper Notcher station.
- Perform complete notch operations only – partial notch cuts may jam the drop off side of the tooling and could result in breakage and operator injury.
- Use notching aids when working with small items at the Coper Notcher station.

### Coper Notcher Operation

Clear the feed table of the Coper Notcher station of any tools or debris prior to powering the machine on.

1. Turn machine on. The top Coper Notcher blade will be in the neutral position. Push the material under the tooling guard and into the blade area. Position your material to the desired cut.
2. Clear your hands from the working area and depress the foot pedal to activate the Coper Notcher station. When the cut is complete, release the foot pedal to automatically return the top Coper Notcher blade to the neutral position.

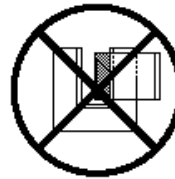

Figure A

**Incorrect use** - material supported on one blade

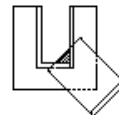

Figure B

**Correct use** - material supported by two blades

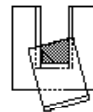
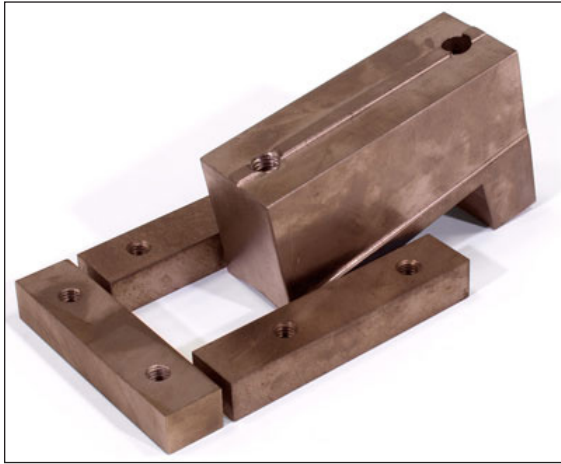

Figure C

**Correct use** - material supported by three blades

## Maintenance - Coper Notcher



### CAUTION

Turn off power to machine by depressing the red stop / off button and lockout upstream power at the main electrical panel.

Observe the following procedure when maintaining the Ironworker Coper Notcher station.

#### Remove and replace moving blade:

1. Remove or swing the Coper Notcher guard assembly up and away from the Coper Notcher table.
2. Remove the two 1/2" socket head cap screws that secure the existing top Coper Notcher blade to the moving center.
3. Clean the keyway in the moving center of any dirt or debris.
4. Install the top Coper Notcher blade with the keyway up and the "foot" of the blade facing the center of the machine. Secure the top blade using two 1/2" socket head cap screws. Tighten bolts.

#### Remove and replace stationary blades:

1. Loosen the set screws (if provided) located at the sides of the Coper Notcher table.
2. The Coper Notcher table includes three blades secured within the table housing. Remove the four 1/2" bolts and washers that secure Coper Notcher table to the base table.
3. Carefully remove the Coper Notcher table assembly to a secure workbench. The top table that holds the blade set is secured by eight 3/8" socket head cap screws - four from the top working surface, four from the underside of the Coper Notcher assembly. Remove all eight cap screws to separate the blade housing from the Coper Notcher assembly. Remove the top table from the assembly.

4. Remove the six 3/8" socket head cap screws that secure the blades into the base table housing.
5. Clean the blade pockets of any dirt or debris.
6. The bottom shear blades have multiple cutting surfaces. Either rotate/flip the existing blade set to the new cutting surfaces or install new cutting blades into the blade pockets. Re-install the six 1/2" socket head cap screws and tighten. The blades should be parallel to each other at the top surface of the working table.
7. Re-install the eight cap screws that secure the top table housing to the bottom table housing.
8. Re-install the Coper Notcher table with the open "U" facing the center of the machine. The guide foot of the top Coper Notcher blade should be centered within the base table blades.
9. Loosely secure the Coper Notcher table from the underside of the base with four 1/2" bolts and washers (provided).
10. Check for top and bottom blade alignment by powering up the machine and slowly inching down the top blade to meet the bottom blades with the foot pedal. Power the machine off.
11. Using a feeler gauge, adjust the clearance between the perimeter of the top and bottom blades to allow for .010" clearance on all three sides.
12. In the event that the top and bottom blades are not aligned, simply loosen the bolts under the table allowing the table to be moved to center the top blade within the bottom blades. When aligned, tighten the table bolts to secure the table.
13. Adjust the set screws (if provided) at the sides of the Coper Notcher table to engage the base Coper Notcher table to the base table. Lock the four 3/8" nuts in place to secure the set screws in place. These added fixtures are to provide additional support to the base table during the notching operation.
14. Swing the Coper Notcher guard back in place.

## Optional Tooling - Auto Cut



### **WARNING**

Auto-Cut tooling is a very useful accessory when production cutting long lengths of material to repeatable lengths. This tooling features a rugged solid-steel spring loaded switch housing, guarding snout, 1" x 48" machined back-gauge rod and electrical controls. The accessory actuates the cutting operation when the plunger switch is activated.

#### Setup

Turn off power to machine by depressing the red stop / off button or lockout upstream power at the main electrical panel.

#### Installing the Auto-Cut Tool:

1. Locate the operations control box on the feed side of the machine.
2. Thread the back gauge rod into the threaded 1" hole in the back of the machine.
3. Install the cross block and actuator rod to the back gauge rod.
4. Adjust the actuator rod towards the back of the machine and align so that the material being sheared will activate the actuator plunger. Adjust the guarding snout to be clear of the material being sheared.
5. Attach the Auto-Cut tool M12 male control cable to the 4-pin female Auto-Cut port.
6. Turn machine ON and turn the power selection at the operations control box to Auto-Cut. The power selection switches power and control from the Ironworker foot-pedal to the Auto-Cut tool.
7. With the shear stations clear of tools and debris, test the Auto-Cut operation by depressing the actuator plunger. The machine should perform a full cut cycle and return to the neutral position.

#### Safe Operation

Observe the following guidelines when operating the Auto-Cut Tool:

- Never exceed the capacities of the machine or tooling as described in the Ironworker specifications or listed at the tooling station.
- Check shear blade clearance at every tooling change or extended shear operation. Maintain proper operating clearance at bar shear and angle shear stations. Failure to maintain clearance will damage shear blades and support brackets.
- Fully engage the material hold-down with the material being cut.
- Do not stack material to cut in the shear station.
- Perform complete shear operations only – partial shear cuts may jam the drop off side of the frame and could result in breakage and operator injury.
- Do not shear angle or flat stock smaller than the hold-down will accommodate.

#### Auto-Cut Operation

1. Clear shear station of any tools or debris prior to powering the machine on.
2. Place iron into the material hold-down and position your cut mark adjacent to the moving shear blade.
3. Secure the iron in the material hold-down by engaging the handscrew or flat bar hold-down into the material.
4. Slide the auto-cut actuator to meet the leading edge of the material projecting through the shear station.
5. With the power off, activate the plunger by pushing the actuator into the material. Tighten the actuator rod to the back gauge rod.
6. Test cut by turning the machine on.
7. Release hold-down pressure slightly to allow material to be pushed through the shear station.
8. Push the material through the shear station to engage the actuator plunger.
9. The machine will cycle and shear the specified material.
10. Check the cut material dimension and adjust as necessary for production cutting.



## Optional Accessory Light



### **WARNING**

Accessory lighting is available as optional tooling. Designed with M12 connections, this super bright LED light plugs in to 2014 and newer Ironworkers and has a 100,000 hour rating. Super durable lexan lens and magnetic base allow you to attach the light on any Ironworker surface.

#### **Accessory work lights contain magnets - Magnet Safety Warning!**

*Disclaimer: Cleveland Steel Tool neither assumes nor accepts any liability for damages resulting from the handling or use of magnets. With your purchase, the buyer confirms that you have read and understood the following warnings, the buyer agrees that he/she is responsible for all damages and injuries caused by magnets, which may include personal injuries, property and magnet damages. The buyer agrees with these terms at time of purchase.*

Neodymium magnets are very strong. Handling them with care is necessary to prevent personal injuries, property damages and magnet damages.

1. Neodymium magnets are brittle; they can be broken or can splinter in a collision. One should wear gloves and protective glasses when handling these magnets, because splinters could disengage and fly from the magnets.

2. Normal Neodymium magnets will lose their magnetic properties if heated above 175°F (80° C).



### **WARNING**

**3. The strong magnetic fields of neodymium magnets can damage items such as television, computer monitors, credit cards, bank cards, computers, diskettes and other data carriers, video tapes, mechanical watches, hearing aids, loud speakers and VCRs. Pacemakers may be damaged or switch to "Test Mode" in the presence of a strong magnetic force, if a pacemaker is in use, keep a minimum of 3 feet distance.**

4. Children should not be allowed to handle neodymium magnets as they can be dangerous. Small magnets pose a choking hazard and should never be swallowed or inserted into any part of the body.

5. Under no circumstances should you try to cut, saw or drill the Neodymium magnets! The resulting dust from the magnet is very flammable.

# Punch Station



Guarding removed for clarity

## **WARNING**

Your Ironworker is capable of punching materials as listed on the capacity labels positioned adjacent to the Punch station.

### Setup

Your Cleveland Steel Tool Ironworker has been shipped with a punch and die installed within the punch station. Punches and dies are wearing parts and will need to be maintained or replaced over time. Refer page 24 for removal and replacement instructions. When changing the punch and die during typical operation please observe the following steps:

**Turn off power to machine by depressing the red stop/off button or lockout upstream power at the main electrical panel.**

1. Swing Stripper Bar away by loosening 4 bolts (2 on either side of punch station) with a 3/4" wrench. After swinging Stripper Bar away, re-tighten one bolt to prevent it falling back on you.
2. Remove punch by loosening the punch nut assembly with factory supplied wrench.
3. Remove die by loosening the set screw at the side or front edge of the punch table and then lifting die from the die holder. If the die resists removal gently tap the die from the underside of the punch table to loosen the die for removal.
4. Install new die and tighten set screw. If loading a shaped die, align the whistle spot with the set screw and tighten.
5. Install new punch and tighten punch nut with wrench. If using a shaped punch, align the locating keystick of the punch with the corresponding slot within the punch stem assembly and tighten the punch nut with the wrench.

6. Check for punch and die alignment by powering up the machine and inching down the punch to meet the die with the foot pedal. Check to see that the punch is centered in the die.
7. In the event that the punch and die are not aligned, loosen the bolts under the table allowing the table to be moved to center the die. When aligned, tighten the table bolts to secure the table.
8. Loosen bolts and swing the stripper bar back in place. Adjust stripper bar for minimal clearance between the top of the material and the bottom of the stripper.

### Safe Operation

**Please observe the following guidelines when operating the Punch Station:**

- Follow manufacturers punch and die clearance recommendations. Follow punch tonnage requirements in Figure 2, page 21.
- Never exceed the capacities of the machine or tooling as described in the Ironworker specifications or listed at the tooling station.
- The thickness of the material you are punching should not exceed the diameter of the punch being used.
- Check punch and die alignment after every tooling change or extended punch operation.
- Adjust the punch stripper supplied with your Cleveland Steel Tool Ironworker to allow for material positioning and material stripping.
- Do not stack material to punch in the punching station.
- Use one or two drops of oil at the punch to aid in stripping material from the punch as well as to extend the life of the punch tooling.
- Punch complete holes only – partial holes will side load the punch tooling and could result in punch breakage and operator injury.
- Use punching aids when working with small items at the punch station.

## Punch Operation

Clear the punch station of any tools or debris prior to powering the machine on.

1. Place the material to be punched between the punch and die. Check to see that your material is spanning the stripper plate and that adequate material is available to safely position the material.
2. Clear your hands from the working area and depress the foot pedal to move the punch through the material and into the die.
3. When the punch is complete, release the foot pedal to automatically strip the material from the punch and return the punch to its neutral position.

### Punch and Die Operating Clearances

Maintain the following clearance between punch and die.

| Material Thickness   | Total Clearance |
|----------------------|-----------------|
| 16 gauge and lighter | .006"           |
| 15 gauge - 13 gauge  | .010"           |
| 3/32" - 5/32"        | 1/64"           |
| 3/16" - 15/32"       | 1/32"           |
| 1/2" - 23/32"        | 1/16"           |
| 3/4" and heavier     | 3/32"           |
| 1" and over          | 1/8"            |

### Punching Capacities

You can determine the tonnage required to punch A36 mild steel (yield strength 36,300 psi, 65,000 psi tensile) by referencing Figure 2 or applying the following formulas for round or shaped holes. For materials other than mild steel please refer to the multiplier table.

### Round Holes

Punch Dia. x Material Thickness x 80 = Tons of pressure required

Example: How many tons of force do I need to punch a 3/8" hole in 1/4" mild steel?  
 $.375 \times .25 \times 80 = 7.5 \text{ tons}$

### Shaped Holes

1/3 Punch Perimeter x Material thickness x 80 = Tons of pressure required

Example: How much force do I need to punch a 3/8" x 1" rectangular hole in 1/4" mild steel?  
 $(.33 \times 2.75) \times .25 \times 80 = 18.1 \text{ tons}$

### Material Multiplier

When punching materials other than mild steel first calculate tonnage as shown above then apply the multiplier for the listed material.

|                            |      |
|----------------------------|------|
| Aluminum (2024-0)          | 0.36 |
| Brass (1/4 hard)           | 0.70 |
| Copper (1/2 hard)          | 0.52 |
| Steel (50% carbon)         | 1.60 |
| Steel (cold rolled) (1018) | 1.24 |
| Stainless Steel (303)      | 1.50 |

## Figure 2 - Punch Tonnage Requirements

| Stock Thickness | Hole Diameter |      |      |       |       |       |       |       |       |       |       |       |       |       |       |
|-----------------|---------------|------|------|-------|-------|-------|-------|-------|-------|-------|-------|-------|-------|-------|-------|
|                 | 1/8           | 3/16 | 1/4  | 5/16  | 3/8   | 7/16  | 1/2   | 9/16  | 5/8   | 11/16 | 3/4   | 13/16 | 7/8   | 15/16 | 1"    |
| 26 ga. (.0179)  | 0.18          | 0.27 | 0.36 | 0.45  | 0.54  | 0.63  | 0.72  | 0.81  | 0.90  | 0.99  | 1.07  | 1.16  | 1.25  | 1.34  | 1.43  |
| 24 ga. (.0239)  | 0.24          | 0.36 | 0.48 | 0.60  | 0.72  | 0.84  | 0.96  | 1.08  | 1.20  | 1.31  | 1.43  | 1.50  | 1.67  | 1.89  | 1.91  |
| 22 ga. (.0299)  | 0.30          | 0.45 | 0.60 | 0.75  | 0.90  | 1.05  | 1.20  | 1.35  | 1.50  | 1.65  | 1.80  | 1.95  | 2.10  | 2.24  | 2.39  |
| 20 ga. (.0359)  | 0.36          | 0.54 | 0.72 | 0.90  | 1.08  | 1.26  | 1.44  | 1.62  | 1.80  | 1.98  | 2.15  | 2.33  | 2.51  | 2.69  | 2.87  |
| 18 ga. (.0478)  | 0.48          | 0.72 | 0.96 | 1.20  | 1.43  | 1.67  | 1.91  | 2.15  | 2.39  | 2.63  | 2.87  | 3.11  | 3.34  | 3.58  | 3.82  |
| 16 ga. (.0598)  | 0.60          | 0.90 | 1.20 | 1.50  | 1.79  | 2.09  | 2.39  | 2.69  | 2.99  | 3.29  | 3.59  | 3.89  | 4.19  | 4.49  | 4.78  |
| 14 ga. (.0747)  | 0.75          | 1.12 | 1.49 | 1.87  | 2.24  | 2.61  | 2.99  | 3.36  | 3.73  | 4.11  | 4.48  | 4.86  | 5.23  | 5.60  | 5.97  |
| 12 ga. (.1046)  | 1.05          | 1.57 | 2.09 | 2.62  | 3.14  | 3.66  | 4.18  | 4.71  | 5.23  | 5.75  | 6.28  | 6.80  | 7.32  | 7.85  | 8.57  |
| 10 ga. (.1345)  |               | 2.02 | 2.69 | 3.36  | 4.04  | 4.71  | 5.38  | 6.05  | 6.73  | 7.40  | 8.07  | 8.74  | 9.42  | 10.09 | 10.76 |
| 3/16 (.187)     |               | 2.81 | 3.74 | 4.68  | 5.61  | 6.50  | 7.48  | 8.42  | 9.35  | 10.29 | 11.22 | 12.16 | 13.09 | 14.03 | 14.96 |
| 1/4 (.250)      |               |      | 5.00 | 6.25  | 7.50  | 8.75  | 10.00 | 11.25 | 12.50 | 13.75 | 15.00 | 16.25 | 17.50 | 18.75 | 20.00 |
| 3/8 (.375)      |               |      |      | 11.25 | 13.13 | 15.00 | 16.88 | 18.75 | 20.63 | 22.50 | 24.38 | 26.25 | 28.13 | 30.00 |       |
| 1/2 (.500)      |               |      |      |       | 20.00 | 22.50 | 25.00 | 27.50 | 30.00 | 32.50 | 35.00 | 37.50 | 40.00 |       |       |
| 5/8 (.625)      |               |      |      |       |       |       |       | 31.25 | 34.38 | 37.50 | 40.63 | 43.75 | 46.88 | 50.00 |       |
| 3/4 (.750)      |               |      |      |       |       |       |       |       |       | 45.00 | 48.75 | 52.50 | 56.25 | 60.00 |       |
| 7/8 (.875)      |               |      |      |       |       |       |       |       |       |       |       | 61.25 | 65.63 | 70.00 |       |
| 1" (1.000)      |               |      |      |       |       |       |       |       |       |       |       |       |       |       | 80.00 |

## Optional Tooling - Oversize 228 Punch and 419 Die Assembly



Guarding removed for clarity

**WARNING**

Cleveland Steel Tool Ironworkers allow for Oversize 228 Punch and 419 Die tooling to be installed in the punch station of your 60 ton Ironworker. 228/419 tooling has a capacity of a 1-1/2" round hole through 5/16" thick mild steel.

### Setup

228/419 tooling includes an 228 punch stripper, 228 punch holder assembly, 419 die table or 419 pedestal die table and an oversized wrench. Punches and dies are wearing parts and will need to be maintained or replaced over time. When installing oversize punch and die tooling please observe the following steps:

Turn off power to machine by depressing the red stop / off button or lockout upstream power at the main electrical panel.

### Install the oversize punch holder:

1. 228 punch tooling can be installed in punch station end of the Ironworker. Remove existing tooling or debris from installation site.
2. Install 228 punch block/stem assembly to the moving center with hardware provided. Tighten assembly to moving center.
3. Insert 228 punch in CNUT228 coupling nut and thread onto oversize punch block /stem assembly. Tighten with wrench provided. If using a shaped punch, align the locating keystone of the punch with the corresponding slot within the punch stem assembly and tighten the punch nut with the wrench.

### Install the 419 oversize pedestal die table:

1. Clear the Ironworker base table of any debris.
2. Install the 419 die table with the die opening facing away from the Ironworker. Align the slotted holes of the die table with the base table holes and insert hardware provided.
3. With die table hardware loosely installed, insert 419 die into die holder and secure with set screw.

4. Turn Ironworker on and inch down the punch to meet the die with the foot pedal jog control. Check to see that the punch is centered within the die.
5. Once punch is aligned with die, turn off power to machine; secure the die table to the Ironworker base table by tightening the hardware provided.
6. Install the oversize punch stripper assembly to the Ironworker frame with the hardware provided.
7. Swing the stripper bar into place allowing for minimal clearance between the top of the material to be punched and the bottom of the stripper and tighten the stripper bar bolts.

### Safe Operation

Observe the following guidelines when operating the Oversize Punch tooling.

- Follow manufacturer punch and die clearance and tonnage recommendations as shown in Figure 2, page 21.
- Never exceed the capacities of the machine or tooling as described in the specifications or listed at the tooling station.
- The thickness of the material you are punching should not exceed the diameter of the punch being used.
- Check punch and die alignment after every tooling change.
- Adjust the punch stripper supplied with your Cleveland Steel Tool Ironworker to allow for material positioning and material stripping.
- Do not stack material to punch in the punching station.
- Use 1 - 2 drops of oil at the punch to aid in stripping material from the punch as well as to extend the life of the punch tooling.
- Punch complete holes only – partial holes will side load the punch tooling and could result in punch breakage and operator injury.
- Use punch aids when working small items at the punch station.

### Oversize Punch Tooling Operation

Clear the punch station of any tools or debris prior to powering the machine on.

1. Place the material to be punched between the punch and die. Check to see that your material is spanning the stripper plate and that adequate material is available to safely position the material.
2. Clear your hands from the working area and depress the foot pedal to move the punch through the material and into the die.
3. When the punch is complete, release the foot pedal to automatically strip the material from the punch and return the punch to its neutral position. When the punch is complete, release the foot pedal to automatically strip the material from the punch and return the punch to its neutral position.

## Optional Tooling - Oversize 241 Punch and 28XX Die Assembly

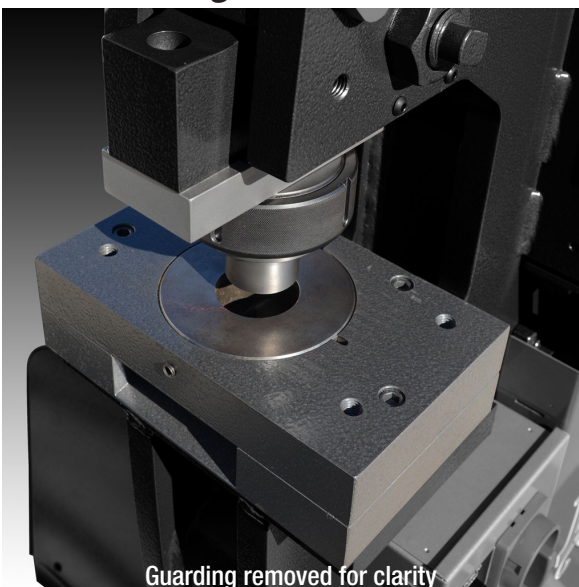

Guarding removed for clarity

### **WARNING**

Cleveland Steel Tool Ironworkers allow for Oversize 241 Punch and 28XX Die tooling to be installed in the punch station of your 60 Ton Ironworker. 241/28XX tooling has a capacity of a 4" round hole through 1/8" thick mild steel.

#### Setup

241 Punch tooling fits within the punch station of the machine. 241/28XX tooling includes an oversize 241 punch stripper, 241 punch holder assembly, 28XX die table and wrench. Punch and dies are wearing parts and will need to be maintained or replaced over time. When installing 241 punch and 28XX die tooling please observe the following steps:

Turn off power to machine by depressing the red stop / off button or lockout upstream power at the main electrical panel. Install the punch holder:

1. Clear any tooling or debris from the tooling installation site.
2. Secure the 241 punch holder to the operating center by first removing the stud from the holder. Place the holder to the operating center with the tapped hole positioned to the outside of the center. Install holder with two 1/2" SHCS bolts and tighten. Install stud to holder with four 3/8" SHCS bolts and tighten.

#### Install the die table:

Place the 28XX die table and slug chute on the support table base and loosely install four 1/2" bolts (provided) through the underside of the support table into the 28XX die table.

1. Install new 28XX die and tighten set screw. If loading a shaped die, align the whistle spot with the set screw and tighten.
2. Install new 241 punch and tighten with spanner wrench. If using a shaped punch, align the locating keystone (not provided) of the punch with the corresponding slot within the punch stem assembly and tighten the punch nut with the wrench.
3. Check for punch and die alignment by powering up the machine and slowly inching down the punch to meet the

die with the foot pedal. Check to see that the punch is centered in the die. Turn off power to machine.

4. Check for punch and die alignment by powering up the machine and slowly inching down the punch to meet the die with the foot pedal. Check to see that the punch is centered in the die. Turn off the power to the machine.
5. In the event that the punch and die are not aligned, simply loosen the bolts under the table allowing the table to be moved to center the die. When aligned, tighten the table bolts to secure the table.
6. Install and secure the 241 stripper bar to the ironworker frame allowing for minimal clearance between the top of the material to be punched and the bottom of the stripper.

#### Safe Operation

Observe the following guidelines when operating the 241 Punch Station.

- Follow manufacturers punch and die clearance recommendations as shown in Figure 2, page 21.
- Never exceed the capacities of the machine or tooling as described in the machine specifications or listed at the tooling station.
- The thickness of the material you are punching should not exceed the diameter of the punch being used.
- Check punch and die alignment after every tooling change or extended punch operation.
- Adjust the punch stripper supplied with your 241 tooling to allow for material positioning and material stripping.
- Do not stack material to punch in the punching station.
- Use one or two drops of oil at the punch to aid in stripping material from the punch as well as to extend the life of the punch tooling.
- Punch complete holes only – partial holes will side load the punch tooling and could result in punch breakage and operator injury.
- Use punching aids when working with small items at the punch station.

#### 241 Punch Operation

1. Clear the punch station of any tools or debris prior to powering the machine on.
2. Turn the Ironworker on and place the material to be punched between the punch and die. Adjust the punch stripper for minimum clearance between stripper plate and material. Check to see that your material is spanning the stripper plate and that adequate material is available beyond the stripper area to safely position the material.
3. Clear your hands from the working area and depress the foot pedal to move the punch through the material and into the die. When the punch is complete, release the foot pedal to automatically strip the material from the punch and return the punch to its neutral position.

## Punch Station - Maintenance



### CAUTION

Your Cleveland Steel Tool Ironworker has been shipped with a punch and die installed within the punch station. When worn or chipped, the punch and die must be replaced. Observe the following procedure when maintaining the ironworker punch station.

**Turn off power to machine by depressing the red stop/off button and lockout upstream power at the main electrical panel.**

**Maintain as follows:**

1. Swing the Punch Stripper up or away from the punch by loosening the stripper assembly bolts.
2. Remove punch by loosening the punch nut assembly with factory supplied wrench.
3. Remove die by loosening the set screw at the side of the punch table and then lifting die from the die holder. If the die resists removal, gently tap the die from the underside of the punch table to loosen the die for removal.
4. Install new die and tighten set screw. If loading a shaped die, align the whistle spot with the set screw and tighten.
5. Install new punch and tighten punch nut with wrench. If using a shaped punch, align the locating keystone of the punch with the corresponding slot within the punch stem assembly and tighten the punch nut with the wrench.
6. Check for punch and die alignment by powering up the machine and inching down the punch to meet the die with the foot pedal. Check to see that the punch is centered in the die.
7. In the event that the punch and die are not aligned, first confirm that the punch is seated properly in the punch nut assembly. If not seated properly, repeat step 5. If seated properly, loosen the bolts under the die table allowing the table to be moved to center the die. When aligned, tighten the table bolts to secure the table and repeat step 6.
8. Swing the stripper bar back in place allowing for minimal clearance between the top of the material and the bottom of the stripper and tighten the stripper bolts.

# Punch and Die Styles

| Model      | Punch | Die |
|------------|-------|-----|
| All Models | 219   | 413 |

**Note:** Cleveland Steel Tool™ Ironworkers use Punch Style 228 or 241 or die Style 419 or 28XX for Oversize Hole Punching.

## PUNCHES

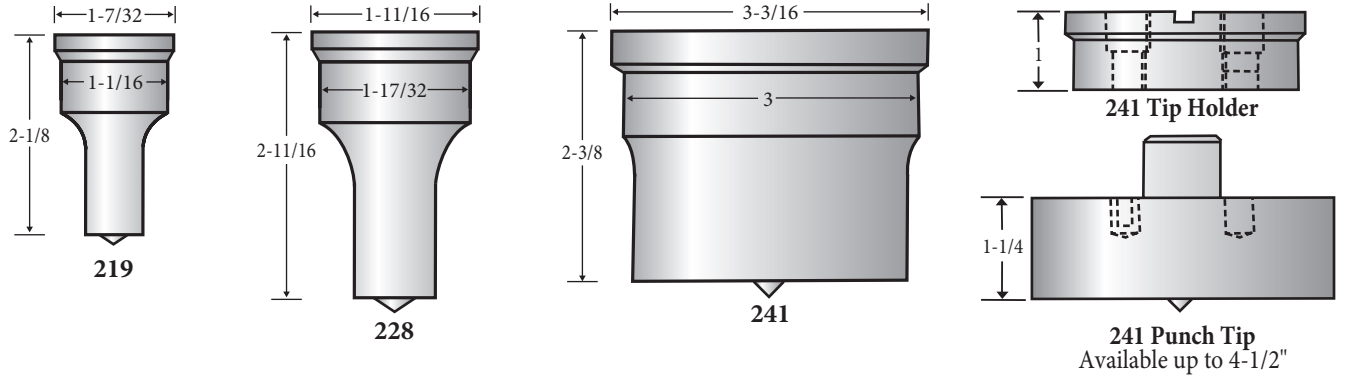

## DIES

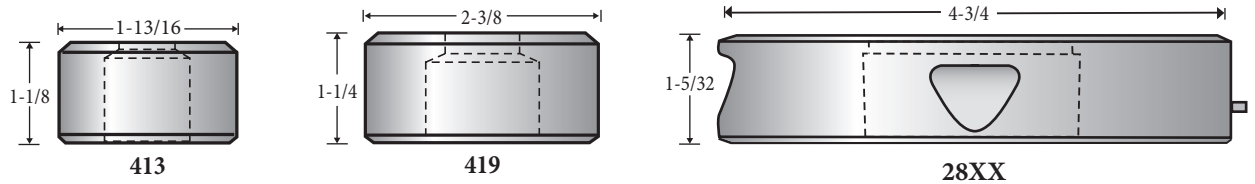

Cleveland Steel Tool Ironworkers use  $1/4$ " x  $1/8$ " Keyways and Whistle Spots for alignment of shaped punches and dies.

## Optional Tooling - Angle Notcher

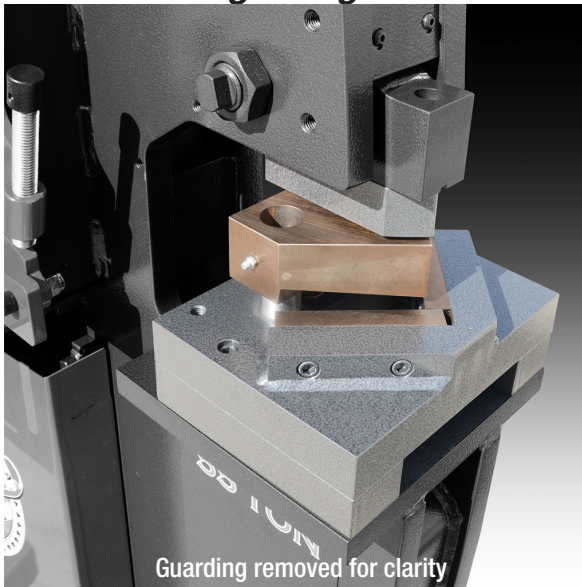

### **WARNING**

Optional Angle Notcher tooling will provide a distortion and burr free, two-sided, 92 degree shear cut to mild steel bar, plate or angle stock. Common use of this tooling is in the fabrication of angle iron frames. Please review capacity labels positioned at the Angle Notching Station.

**Turn off power to machine by depressing the red stop / off button or lockout upstream power at the main electrical panel.**

#### Setup

Optional tooling and accessories fit within the punch station of the machine. Your Angle Notcher is equipped with one, two-sided top Notcher blade and two, four-sided bottom blades. The top blade is mounted on guide pins and return springs of the tooling base. The moving "center" of the ironworker, pushes on the top Angle Notch blade via the accessory push block. If ordered as a factory installed option, your Angle Notcher assembly is setup for immediate operation. If ordered as an option, the punch station of the machine must be cleared of any existing tooling, material or debris prior to tooling installation. Angle Notcher blades are wearing parts and will need to be maintained or replaced over time. Refer to the maintenance section for blade maintenance, removal and replacement. To setup your Angle Notching station please observe the following steps:

#### Install the push block:

Install the push block to the moving center. The V-shaped end of the push block should be pointing away from the machine. Secure the push block with bolts provided.

#### Install the Angle Notcher assembly:

1. Place the Angle Notcher assembly on the Ironworker support table with the "V" pointing away from the machine.
2. Loosely secure the table from the underside of the base with four 1/2" bolts and washers (provided).

3. Check for push block and top blade alignment by powering on the machine and slowly inching down the push block to meet the top blade with the foot pedal. Power the machine off.
4. In the event that the push block and top blade are not aligned, simply loosen the bolts under the table allowing the table to be moved to center the push block centerline to the top blade. When aligned, tighten the table bolts to secure the table.
5. Install the Angle Notcher guard with the bolts provided.

#### Safe Operation

Observe the following guidelines when operating the Angle Notcher Station.

- Never exceed the capacities of the machine or tooling as described in the machine specifications or listed at the tooling station.
- Check Angle Notcher blade clearance at every tooling change or extended notcher operation. Maintain .010" clearance between top and bottom notcher blades at all times. Failure to maintain clearance will damage blades and support pockets.
- Cut with a minimum of two sides of the blade surfaces engaging the material being notched. Cutting on one blade surface may overload the blades and result in tooling damage or injury to the operator.
- Do not stack material to cut in the Angle Notcher station.
- Perform complete notch operations only – partial notch cuts may jam the drop off side of the tooling and could result in breakage and operator injury.
- Use notching aids when working with small items at the Angle Notcher station.

#### Angle Notcher Operation

1. Clear the feed table of the Angle Notcher station of any tools or debris prior to powering the machine on.
2. Turn machine on. The top Angle Notcher blade will be in the neutral position. Push the material under the tooling guard and into the blade area. Position your material to the desired cut.
3. Clear your hands from the working area and depress the foot pedal to activate the Angle Notcher. When the cut is complete, release the foot pedal to automatically return the top Angle Notcher blade to the neutral position.



## Maintenance - Angle Notcher

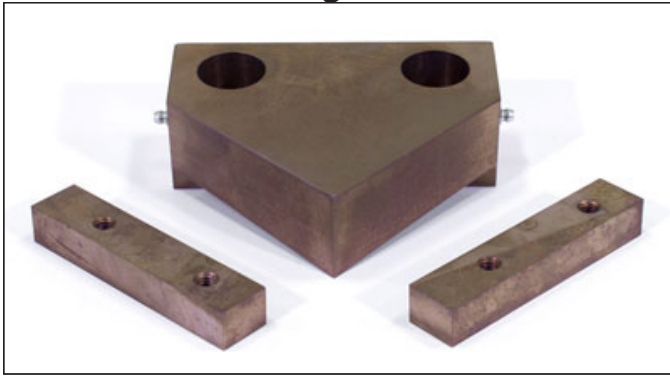

### CAUTION

Turn off power to machine by depressing the red stop/off button and lockout upstream power at the main electrical panel.

Observe the following procedure when maintaining the Ironworker Angle Notcher station.

#### Remove and replace moving blade:

1. Remove the Angle Notcher guard assembly from the Angle Notcher table.
2. Remove the two 1/2" socket head cap screws that secure the Angle Notcher push block to the moving center.
3. Clean the keyway in the moving center of any dirt or debris.
4. With the push block removed, lift the moving top blade from the guide pin assembly. Clean and lubricate the guide pins and reinstall new moving top blade.

#### Remove and replace stationary blades:

1. The Angle Notcher base table includes two blades secured within the table housing. Remove the four 1/2" socket head cap screws that secure the blades into the blade supports of the base table housing.
2. Clean the blade pockets of any dirt or debris.
3. The bottom shear blades have multiple cutting surfaces. Either rotate/flip the existing blade set to the new cutting surfaces or install new cutting blades into the blade pockets. Re-install the four 1/2" socket head cap screws and tighten. The blades should be parallel to each other at the top surface of the working table.
4. Reinstall the push block to the moving center with the two 1/2" socket head cap screws provided.
5. Check for top and bottom blade alignment by powering up the machine and slowly inching down the top blade to meet the bottom blades with the foot pedal. Power the machine off.
6. Using feeler gauge, confirm the clearance between the perimeter of the top and bottom blades to allow for .010" clearance on two sides.
7. Periodically lubricate the Angle Notcher assembly with the grease fittings supplied as indicated on the tooling.

## Optional Tooling - Press Brake Tooling



### **WARNING**

The 60 Ton Cleveland Steel Tool Ironworker can accommodate an 8" or 10" Press Brake. Press Brake tooling will allow for the graduated bending of 1/16", 3/16", 1/8" and 1/4" flat stock up to 90 degrees. This tooling is most effective when operated with the factory installed Electric Stroke Control feature.

### Setup

Press Brake tooling can be accommodated in the punch station of the machine. Press Brake tooling includes one mounting bracket to secure the "punch" to the center of the machine, one "punch", one "4-way die", and two bottom brackets that secure the "die" to the base table. The moving "center" of the ironworker, pushes the top punch into the shaped die to bend the specified material. If ordered as a factory installed option, your Press Brake assembly is setup for immediate operation. If ordered as an option, the open station or punch station must be cleared of any existing tooling, material or debris prior to tooling installation. To setup your Press Brake, please observe the following steps:

#### Install the punch holder:

1. Remove all tooling and guarding from the open station or punch station.
2. Secure the punch holder to the moving "center" with bolts provided. The 1/2" tapped hole is positioned to the outside of the machine.
3. Position punch in the holder so that the milled relief in the keyway slips over the holder bolt. Tighten set screws in the holder to secure the punch.
4. Depress the foot pedal to activate the Press Brake station. When the Press Brake operation is complete, release the foot pedal to return the punch to the neutral position.

#### Install the 4-Way Die:

1. Place the die assembly on the Ironworker support table.
2. Loosely secure the two support brackets to the support table from the underside of the base with four 1/2" bolts, nuts and washers (provided).
3. Check for punch and die alignment by powering on the machine and slowly inching down the punch to meet the bottom die with the foot pedal. Power the machine off.
4. In the event that the punch and die are not aligned, simply loosen the bolts under the table allowing the die block to be moved to center the punch. When aligned, tighten the table bolts to secure the table.
5. Select 1/16", 3/16", 1/8" or 1/4" test material for bending. Rotate your four-way die to your selected material thickness. Power the machine on and jog the center down until the punch pushes the sample material into the die. If the punch stops before the material has been formed to a 90 degree angle, a small steel shim must be placed between the die and support table.
6. Re-install all guarding to the machine prior to machine use.

#### Safe Operation

Observe the following guidelines when operating the Press Brake Station.

- Never exceed the capacities of the machine or tooling as described in the Ironworker specifications or listed at the tooling station.
- Keep the Press Brake tooling clean.
- Check Press Brake clearance and alignment at every tooling change, maintenance cycle or extended Press Brake operation. Failure to maintain proper clearance may damage punch, die and support brackets or adjacent tooling.
- Press material towards the center of the Press Brake length.
- Do not stack material in the Press Brake station.
- When not in use, remove the Press Brake die from the holder.

#### Press Brake Operation

1. Clear the station of any tools or debris prior to powering the machine on.
2. Turn the Ironworker on and place the material to be "broken" on top of the bottom die.
3. Center your material within the length of the bottom die. Bending material to the front or back of the Press Brake die may damage your Ironworker.
4. Position your material for the desired Press Brake. Clear your hands from the working area and depress the foot pedal to activate the Press Brake station. When the Press Brake operation is complete, release the foot pedal to return the punch to the neutral position.

## Maintenance - Press Brake Tooling

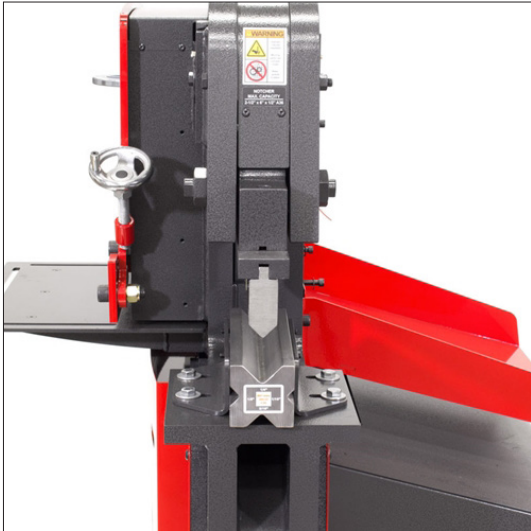

### CAUTION

Turn off power to machine by depressing the red stop/off button and lockout upstream power at the main electrical panel.

Observe the following procedures when maintaining or replacing components of the Ironworker Press Brake station.

#### Remove and replace moving Punch:

1. While supporting the punch, carefully remove the allen screws that secure the punch to the punch holder. Remove the punch.
2. If the punch holder requires replacement, remove the two 1/2" socket head cap screws from the punch holder assembly. Remove punch holder.
3. Clean the keyway in the moving center of any dirt or debris.
4. Install the new punch holder with the two 1/2" socket head cap screws. The 1/2" tapped hole is positioned to the outside of the machine. Tighten the assembly into the moving center.
5. Position punch in the holder so that the milled relief in the keyway slips over the holder bolt. Tighten set screws in the holder to secure the punch.
6. Re-install all guarding to the machine prior to machine use.

#### Remove and replace stationary Four-Way Die:

1. Remove four 1/2" bolts, nuts and washers from the die support brackets.
2. Remove support brackets.
3. Remove old die assembly.
4. Place new die assembly on the Ironworker support table.
5. Loosely secure the two support brackets to the support table from the underside of the base with four 1/2" bolts, nuts and washers (provided).
6. Check for punch and die alignment by powering on the machine and slowly inching down the punch to meet the bottom die with the foot pedal. Power the machine off.
7. In the event that the punch and die are not aligned, simply loosen the bolts under the table allowing the die block to be moved to center the punch. When aligned, tighten the table bolts to secure the table.
8. Select 1/16", 3/16", 1/8" or 1/4" test material for bending. Rotate your four-way die to your selected material thickness. Power the machine on and jog the center down till the punch pushes the sample material into the die. If the punch stops before the material has been formed to a 90 degree angle, a small steel shim must be placed between the die and support table.
9. Re-install all guarding to the machine prior to machine use.

## Optional Tooling - Pipe Notcher



Guarding removed for clarity

### **WARNING**

Pipe Notcher tooling will provide a distortion and burr free, notch cut to mild steel pipe and tube stock. Common use of this tooling is in the fabrication of saddle connections for motorcycle and race car tube frames, tube fences etc. Please review the capacity labels listed in the machine specifications as well as positioned at the Pipe Notching Station.

#### Setup

Pipe Notcher tooling fits within the punch station of the machine. A Pipe Notcher tooling assembly includes one push block, one top Notcher die, one bottom Notcher die and a die table. (Pipe Notcher Tooling for the 100 Ton Deluxe and 120 Ton Ironworkers also includes a slug chute.) The top die is mounted within a spring loaded guide housing mounted to the die table. The bottom die attaches to the face of the guide housing and is machined with a saddle to aid in centering and guiding pipe sections into the die housing. The moving "center" of the Ironworker, pushes on the top Notcher die via the accessory push block. If ordered as a factory installed option, your Pipe Notcher assembly is setup for immediate operation. If ordered as an option, the open cavity of the machine must be cleared of any existing tooling, material or debris prior to tooling installation. To setup your Pipe Notcher station please observe the following steps:

**Turn off power to machine by depressing the red stop / off button or lockout upstream power at the main electrical panel.**

#### Install the push block:

1. Remove all tooling and guarding from the open station.
2. Install the push block supplied with the Pipe Notcher assembly to the moving center of the Ironworker. Secure the push block with bolts provided.

#### Install the Pipe Notcher Assembly:

1. Place the Pipe Notcher assembly on the Ironworker support table with the bottom die pointing away from the machine.

2. Loosely secure the table from the underside of the base with four 1/2" bolts and washers (provided).
3. Check for push block and top die alignment by powering on the machine and slowly inching down the push block to meet the top die with the foot pedal. Power the machine off.
4. In the event that the push block and top die are not aligned, simply loosen the bolts under the table allowing the table to be moved to center the push block centerline to the top blade. When aligned, tighten the table bolts to secure the table.
5. Power the machine on and jog the center down. The pipe dies will close or bypass each other. The push block should not come in contact with the die housing.

#### Safe Operation

Observe the following guidelines when operating the Pipe Notcher tooling:

- Never exceed the capacities of the machine or tooling as described in the Ironworker specifications or listed at the tooling station.
- Keep the Pipe Notcher tooling clean. When dirt or metal chips accumulate, remove 5/16-18 x 1/2" limit screw located in the center at the rear of punch. Lift out punch holder and two springs. Clean holder with solvent or kerosene.
- Check Pipe Notcher blade clearance and alignment at every tooling change, maintenance cycle or extended Pipe Notcher operation. Maintain .010 clearance between Pipe Notcher blades at all times. Failure to maintain clearance will damage blades and support pockets.
- Do not stack material to cut in the Pipe Notcher station.
- Perform complete notch operations only – partial notch cuts may jam the drop off side of the tooling and could result in breakage and operator injury.
- Use notching aids when working with small items at the Pipe Notcher station.

#### Pipe Notcher Operation

1. Clear the feed table of the Pipe Notcher station of any tools or debris prior to powering the machine on.
2. Turn machine on. The top Pipe Notcher die will be in the neutral position. Push the material into the blade area. Position your material to the desired cut.
3. Clear your hands from the working area and depress the foot pedal to activate the Pipe Notcher station. When the cut is complete, release the foot pedal to automatically return the top Pipe Notcher die to the neutral position.

## Maintenance - Pipe Notcher



### CAUTION

Turn off power to machine by depressing the red stop/off button and lockout upstream power at the main electrical panel.

Observe the following procedure when maintaining the Ironworker Pipe Notcher station.

#### Remove and replace moving blade:

1. Remove the two 1/2" socket head cap screws that secure the Pipe Notcher push block to the moving center.
2. Clean the keyway in the moving center of any dirt or debris.
3. With the push block removed, lift the moving top blade from the guide assembly. Clean and lubricate the guide assembly and reinstall new moving top blade.

4. Re-install the push block to the moving center with the two 1/2" socket head cap screws provided.

#### Remove and replace stationary blade:

1. The Pipe Notcher base table includes one blade secured within the table housing. Remove the two 1/2" socket head cap screws and washers that secure the blade into the base table housing.
2. Clean the blade pocket of any dirt or debris.
3. Install new cutting blade into the blade pocket. Re-install the two 1/2" socket head cap screws and washers provided and tighten.
4. Check for top and bottom blade alignment by powering up the machine and slowly jog the center down. The pipe dies will close or bypass each other. The push block should not come in contact with the die housing.
5. Periodically lubricate the Pipe Notcher assembly as indicated on the tooling.

## Optional Tooling - Rod Shear/Multi-Shear



### **WARNING**

Rod Shear or Multi-Shear Tooling will provide distortion and burr free cuts to mild steel rod, square, bar and small angle stock as listed on the assembly.

***Rod Shear and Multi-Shear Blades are factory set to proper clearances and are ready to begin notching operations. Clearances should not be altered.***

Turn off power to machine by depressing the red stop / off button or lockout upstream power at the main electrical panel.

### Setup

Rod Shear or Multi-Shear Tooling fit within the punch station or open tooling cavity of the machine. Verify recommended location per Ironworker model below. Cleveland Steel Tool Rod Shear or Multi-Shear Tooling consists of a housing which holds a stationary blade, a moving blade, return springs and a push block. The moving "center" of the Ironworker, "bumps" the top moving blade via the push block to shear the material. If ordered as a factory installed option, your assembly is setup for immediate operation. If ordered as an option, the open or punch cavity of the machine must be cleared of any existing tooling, material or debris prior to tooling installation. To setup your Rod Shear or Multi-Shear Tooling please observe the following steps:

Identify install location:

60 Ton                      punch station

### Install the assembly:

1. Remove all tooling and guarding from the appropriate punch station or open station.
2. Place the Rod Shear or Multi-Shear assembly on the Ironworker support table with the push block in line with the moving center.
3. Loosely secure the table from the underside of the base with four 1/2" bolts and washers (provided).
4. Check for push block and moving center alignment by powering on the machine and slowly inching down the center to meet the push block with the foot pedal. Power the machine off.
5. In the event that the push block and top die are not aligned, simply loosen the bolts under the table allowing the tooling to be moved to center the push block with the moving center. When aligned, tighten the table bolts to secure the table.
6. Power the machine on and jog the center down. The moving blade will close or bypass the fixed blade. The push block should not come in contact with the die housing.

### Safe Operation

Observe the following guidelines when operating any Rod Shear or Multi-Shear Tooling

- Never exceed the capacities of the machine or tooling as listed at the tooling station.
- Keep the tooling clean.
- Do not stack cut material.
- Perform complete shearing operations only – partial cuts may jam the tooling and could result in breakage and operator injury.
- Use shearing aids when working with small items at the Rod Shear or Multi-Shear Tooling station.

### Rod Shear/Multi-Shear Operation

1. Clear the work area of any tools or debris prior to powering the machine on.
2. Turn the Ironworker on and insert material through the tooling guard and into the blade area. Position your material for the desired cut.
3. Clear your hands from the working area and depress the foot pedal to activate the tooling station.
4. When the cut is complete, release the foot pedal to automatically return the tooling to the neutral position.

## Maintenance - Rod Shear/Multi-Shear

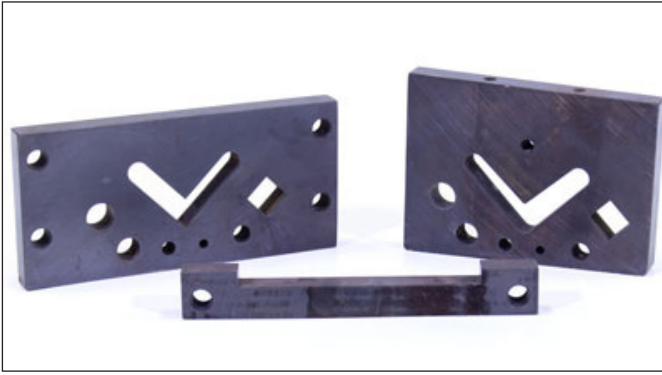

### CAUTION

Turn off power to machine by depressing the red stop/off button and lockout upstream power at the main electrical panel.

*Clearances should not be altered. When all cutting edges are worn, replace blades.*

Observe the following procedures when maintaining or replacing components of the Rod or Multi-Shear assemblies:

#### Remove and replace moving blade:

1. Remove Rod Shear or Multi-Shear assembly from tooling station by removing the four 1/2" bolts, nuts and washers.
2. Remove the two 1/2" allen head screws that secure the push block to the moving blade. Remove damaged blade from base housing. Reserve the push block and return springs for installation of new blade.
3. Clean the push block and return springs of any dirt or debris.
4. Install new moving top blade to push block with allen head screws provided. Re-install return springs. and return moving blade to base housing.

#### Remove and replace stationary blade:

1. The Rod Shear or Multi-Shear assembly includes one or two blades secured within the base housing. Remove the six 1/2" socket head cap screws and spacers that secure the guard and blade into the base housing.
2. Clean the blade pocket of any dirt or debris.

3. Install new cutting blades into the blade pocket. Re-install the guarding and the six 1/2" socket head cap screws and spacers provided and tighten.
4. Check for moving and stationary blade alignment by powering up the machine and slowly jog the center down. The blades will bypass each other. The push block should not come in contact with the base housing.
5. Periodically lubricate the Rod Shear or Multi-Shear assembly as indicated on the tooling.

## Optional Tooling - Factory Installed Hydraulic Accessory Package



### **WARNING**

The Hydraulic Accessory Package is a *factory installed* option that is ready to power any Cleveland Steel Tool Hydraulic Accessory Tool. The Hydraulic Accessory Package includes hydraulic input and output, quick connect/disconnect hardware and a series of female M12 connections allowing for the control of your hydraulic accessory tool, limit switch and auto-cut tooling. To install your accessory tool please observe the following steps:

#### Setup

Turn off power to machine by depressing the red stop / off button or lockout upstream power at the main electrical panel.

Install the Cleveland Steel Tool Hydraulic Accessory Tool:

1. Locate the operations control box adjacent to the starter box on the feed side of the machine.
2. Locate the hydraulic quick connections and accessory controls adjacent to drop-off side or end cap of the machine.
3. Locate the Cleveland Steel Tool hydraulic accessory tool IMMEDIATELY ADJACENT TO IRONWORKER.
4. With the Ironworker power off, install the male and female accessory hydraulic hoses to the ironworker male and female quick connect hydraulic fittings. Both fittings have a detent ball setting that must be aligned to couple and uncouple hoses.
5. Attach the accessory tool male M12 power cable, to the M12 female limit switch port.

6. Attach the accessory tool control OUT / IN, male M12 control cable to the M12 female accessory control port.
7. Turn machine ON and turn the power selection at the operations control box to Accessory. The power selection switches power and control from the Ironworker to the accessory tool.



Visit our website to view our Ironworkers in action.  
<https://www.clevelandsteeltool.com/catalog-and-literature/videos>



# 60 Ton Exploded View

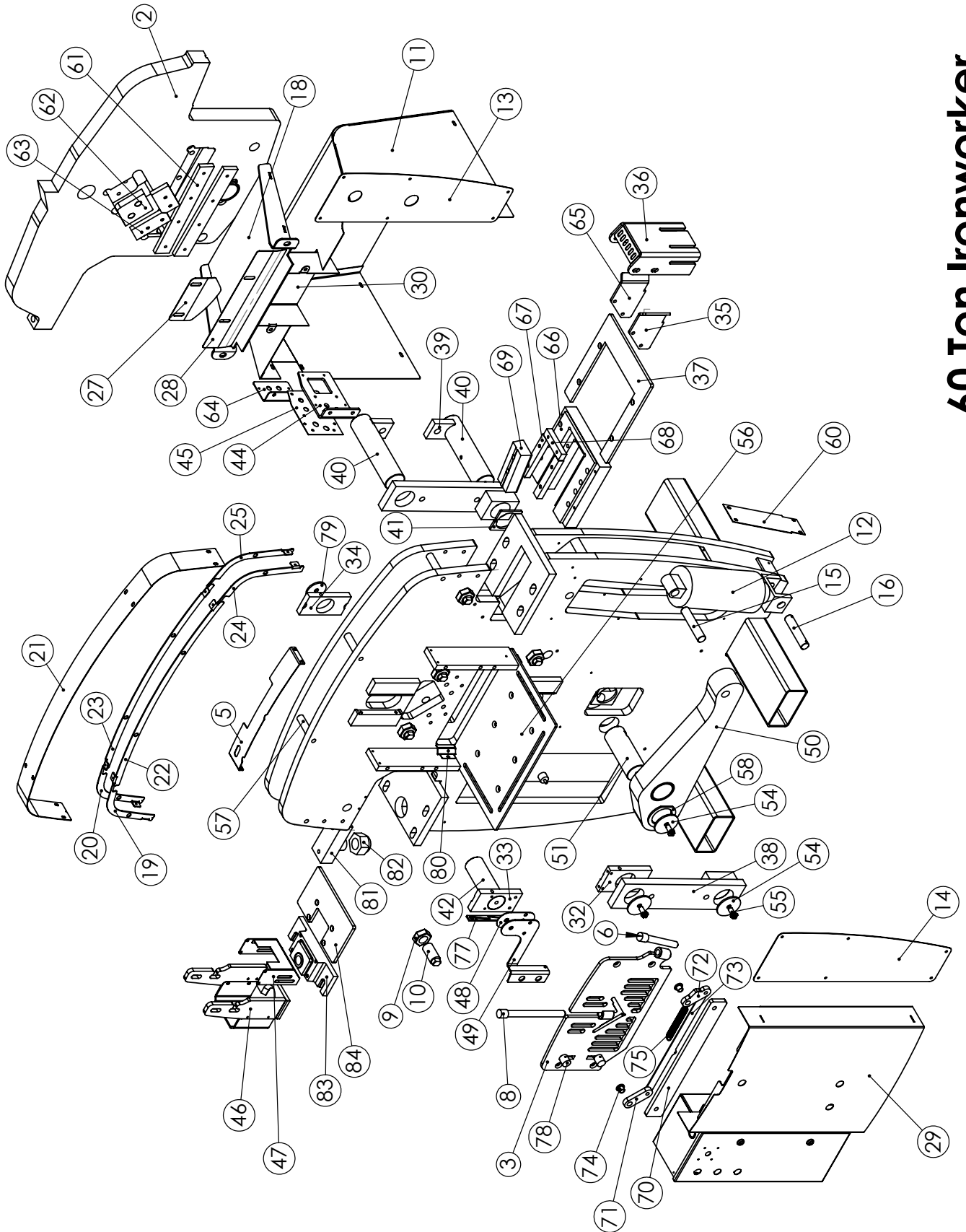

**60 Ton Ironworker** 11/2014

# 60 Ton Parts List

| ITEM NO. | PART NUMBER    | DESCRIPTION                                | QTY. |
|----------|----------------|--|------|
| 2        | CE60           | Center - Complete 60T                      | 1    |
| 3        | GRD626         | Guard Assembly - 60T                       | 1    |
| 5        | CO325          | Cover - Angle Drop Top 55,60T              | 1    |
| 6        | HD636          | Holddown Rod Assy - Flat Grd 50,55,60T     | 1    |
| 8        | HD637          | Holddown Rod Assy - Angle 50,55,60         | 1    |
| 9        | GIB10015-04761 | Nut - Gib Pin 50-120T                      | 12   |
| 10       | GIB0128-04GL   | Gib Assy - Greaseless 25 - 120T            | 12   |
| 11       | CO230          | Cover - Motor Assy. 50,55,60T              | 1    |
| 12       | CY5007-01      | Cylinder #7,50,55,60                       | 1    |
| 13       | GRD323         | Guard - Cylinder Cover Back 55,60          | 1    |
| 14       | GRD321         | Guard - Cylinder Cover Front 55,60T        | 1    |
| 15       | CY337          | Pin - Top Cylinder 50,55,60T               | 8    |
| 16       | CY10202        | Pin - Bottom Cylinder 50,55,60T            | 1    |
| 18       | TA357          | Drop Off Table Assy 55,60T                 | 1    |
| 19       | HM586          | Brkt - Dust Cover Punch Side Frt 60T       | 1    |
| 20       | HM586-2        | Bracket - Dust Cover Punch Side Back 60T   | 1    |
| 21       | CO589          | Cover - Top Dust 60T                       | 1    |
| 22       | HM588          | Bracket - Top Dust Cover 60T               | 1    |
| 23       | HD588-2        | Bracket - Top Dust Cover Back 60T          | 1    |
| 24       | HM587          | Brkt - Dust Cover Notcher Side Frt 60T     | 1    |
| 25       | HM587-2        | Bracket - Dust Cover Notcher Side Back 60T | 1    |
| 27       | GRD327         | Guard - Angle Drop Off 50,55,60T           | 1    |
| 28       | GRD328         | Guard - Flat Drop-off 55,60T               | 1    |
| 29       | GRD575         | Guard Assy - Front Link 55,60T             | 1    |
| 30       | CO232          | Cover - Link 50,55,60T                     | 1    |
| 32       | GB316          | Guide Block - Bottom 50,55,60T             | 2    |
| 33       | GB317          | Guide Block Top 50,55,60T                  | 1    |
| 34       | GB136-00       | Guide Block Top 50,55,60T                  | 1    |
| 35       | GRD366         | Guard - Notcher Angle 60T                  | 1    |

| ITEM NO. | PART NUMBER | DESCRIPTION                                  | QTY. |
|----------|-------------|--|------|
| 36       | GRD605      | Guard - Notcher Assy 60T                     | 1    |
| 37       | TA279       | Table Notcher Std. 60,65,75,100DLX           | 1    |
| 38       | LI354       | Link Assy 50,55,60T                          | 2    |
| 39       | HM55-48     | Retainer Block 50,55,60T                     | 3    |
| 40       | PH313       | Pin Link 50,55,60T                           | 2    |
| 41       | LI457       | Washer - Link Spacer 50,55,60T               | 2    |
| 42       | PS314       | Pin - Guide Block Top 50,55,60T              | 1    |
| 44       | HM344       | Accessory Hose Bracket 50,55,60T             | 1    |
| 45       | HM544       | Accessory M12 Bracket 50,55,60T              | 1    |
| 46       | GRD359      | Stripper Bar Assy 40-60T                     | 1    |
| 47       | GRD557      | Guard Assy - Stripper Back 40-60T            | 1    |
| 48       | SC355       | Shim - Stroke Control 50,55,60T              | 1    |
| 49       | SC310       | Proximity Mount - Stroke Control 55,60       | 1    |
| 50       | WH686       | Whale Assy 55,60T                            | 1    |
| 51       | PH315       | Pin - Btm Whale Pivot 50,55,60T              | 1    |
| 54       | HM0116-04   | Washer 3" OD X .531 ID X.188                 | 3    |
| 55       | HM185-00    | 1/2-13 Grease Bolt Assy.                     | 3    |
| 56       | FT322       | Table Feed - Platform 55,60T                 | 1    |
| 57       | GU330       | Gusset - Standoff 40,50,55,60                | 4    |
| 58       | HM695       | Whale Spacer 50,55,60T                       | 1    |
| 60       | GU350       | Gusset - Cover 50,55,60T                     | 1    |
| 61       | BL413-01    | Blade - Flat Bar Blade 55,60T                | 2    |
| 62       | BL320-00    | Blade Top Angle 40,50,55,60T                 | 1    |
| 63       | BL321-00    | Blade - Bottom Angle Complete 50,55,60T      | 2    |
| 64       | HM493       | Bracket - Auto Cut and Light                 | 1    |
| 65       | GRD366-Bk   | Guard - Notcher Angle Back 60T               | 1    |
| 66       | TA373       | Table Notcher Housing - 55-100T,E110,E110/65 | 1    |
| 67       | BL100-37    | Blade - Notcher Bottom 6-1/4                 | 2    |
| 68       | BL125-22-01 | Blade - Notcher Bottom 4-1/4                 | 1    |
| 69       | BL115-41    | Top Notcher Blade 60,65,75,100DLX,120T       | 1    |

| ITEM NO. | PART NUMBER     | DESCRIPTION                           | QTY. |
|----------|-----------------|---------------------------------------|------|
| 70       | HD319           | Holddown - Flat Bar 55,60T            | 1    |
| 71       | HD0179-00-3     | Swing Link 50,55,60T                  | 1    |
| 72       | HD0178-00-6     | Swing Link W/Cam 50,55,60             | 1    |
| 73       | HD351           | Spring Hook Flat Return 55,60T        | 1    |
| 74       | HD40-161        | Bushing - Swing Link 40-60T,E110/65   | 2    |
| 75       | HM-SC1030-S     | Spring - V 20                         | 1    |
| 77       | GB127-00        | Brass Slide Insert for Guide Block B  | 8    |
| 78       | HD650703P-KNOB  | Knob - Guard 40-60T                   | 2    |
| 79       | HM0116-01       | Washer 2.5" OD X .531 ID X.188        | 1    |
| 80       | HM799           | Wire Protector                        | 1    |
| 81       | PH819-02        | Punch Holder/Stud Assy.               | 1    |
| 82       | PH222-00        | Punch Nut Standard                    | 1    |
| 83       | TA314           | Pedestal Die Table - Base             | 1    |
| 84       | TA903-2         | Pedestal Die Table - Top              | 1    |
| 86       | Elec. Enclosure | Electrical Encl. Call for Part Number | 1    |
| 87       | C8031036C500    | Starter Mount 1/4"                    | 4    |

## Troubleshooting

### **WARNING**

Your Cleveland Steel Tool Ironworker is designed for years of trouble-free use. In the event of operational problems, refer to the following troubleshooting strategies prior to contacting Cleveland Steel Tool. Turn off power to machine by depressing the red stop / off button or lockout upstream power at the main electrical panel before any trouble shooting activity.

| Problem   | Solution   |
|---|--|
| Machine runs but will not cycle                             | Check rotation of motor<br>Check correct amp/voltage to machine<br>Check drive key is in place<br>Check foot pedal cable obstruction<br>Check power supply for green light<br>Check electric foot pedal for obstruction<br>Check proximity switches                              |
| Machine cycles down but will not return to neutral position | Check rotation of motor<br>Check return spring at valve<br>Check foot pedal linkage  |
| Machine turns off after short time in use                   | Check correct amp/voltage to machine   |
| Electric stroke option malfunction                          | Check correct amp/voltage to machine<br>Check fuse at starter box<br>Check fuse at transformer box<br>Check for loose microswitch connections<br>Check for damaged microswitch   |
| Distortion of small angle shear cut                         | Check radius orientation of blade  |
| Brass shavings below gib-pins and slides                    | Brass shavings are common and expected during the break-in period and after blade maintenance  |
| Hydraulics feel hot after operation                         | Hydraulic system operates within the 160 – 190 degree Fahrenheit range   |
| Shear blades or punch and die do not close completely       | Check for notch tooling obstruction<br>Check for Press Brake tooling obstruction   |
| Punch and die misalignment                                  | Check that punch is tight in holder<br>Check that punch stud is secure in block<br>Check for table alignment   |
| Machine will not complete punch or shear operation          | Check tonnage of machine rating against steel hardness and thickness<br>Check for work station obstruction<br>Check foot pedal linkage<br>Check hydraulic fluid level<br>Check slides for wear or obstruction<br>Check electric stroke control option<br>Check die support plate |
| Hydraulic oil overflow/foaming at breather cap              | Check hydraulic fluid level<br>Check for loose hose coupling   |



[www.clevelandsteeltool.com](http://www.clevelandsteeltool.com)

474 E. 105th St. • Cleveland, OH 44108

**800-446-4402**